

CITY OF RIVERSIDE COUNCIL MEETING AGENDA
RIVERSIDE FIRE DEPARTMENT
271 E 1ST ST
REGULAR MEETING

Monday, March 15, 2021 – 6:00 P.M.

The meeting will be recorded and can be viewed live by visiting the city web site at www.riversideiowa.gov

NOTICE TO THE PUBLIC: This is a meeting of the City Council to conduct the regular business of the City. Every item on the agenda is an item of discussion and action if needed.

1. Call meeting to order
2. Approval of agenda
3. Consent agenda
 - a. Minutes from 3-1-2021
 - b. Expenditures for 3-15-2021
 - c. January/February Fire Department Report
4. **Public forum:** 3 minutes per person. See guidelines for public comments at the Clerk's table.
5. Washington County Sheriff Report
6. Highland Post Prom Color Run Fundraiser
7. Request for crosswalk at Cherry Street and Kleopfer Street
8. Fire Department Annual Report
9. Fire Department request for Scene Lights and Bumper for Engine 161
10. PeopleService Inc
11. Public Hearings, Resolutions, Ordinances
 - a. Public Hearing for Sale of Real Estate
 - b. Resolution #031521-01 Approve Sale of Real Estate
12. Discussion on Eagle Scout Project
13. City Administrator's report
 - a. Monthly Financials
 - b. Request to attend Spring IMFOA in Des Moines April 22-23, 2021
 - c. Discussion on Downtown Reinvestment Grant
 - d. Leaf pickup program
14. Motion to adjourn

Meeting attendees are asked to maintain 6 ft. distance from other attendees who don't live in their household. Masks are required when distancing cannot be maintained. Those wishing to provide comments for the public forum without attending the meeting can submit them by email to admin@cityofriversideiowa.com, by phone at 319-648-3501, or in the City Hall dropbox up to 30 minutes prior to the meeting.

RIVERSIDE CITY COUNCIL MEETING: Monday, March 1st, 2021

The Riverside City Council meeting opened at 6:00 pm at the Fire Station with Mayor Allen Schneider requesting roll call. Council members present: Andy Rodgers, Lois Schneider, Tom Sexton, Edgar McGuire, and Jeanine Redlinger.

Motion by Sexton to approve agenda. Second by McGuire, passed 5-0.

Sexton moved to approve the minutes of February 15th, 2021, expenditures, Casey's #3900 liquor license renewal, and Fireworks display permit for Riverside Casino and Golf Resort. Second by McGuire, passed 5 -0.

Nick Oriano addressed council on possible upgrades to the basketball court in Hall Park for his Eagle Scout project.

Redlinger moved to open the Public Hearing of proposed City Budget for Fiscal Year June 2022 at 6:09 pm. Second by Schneider, passed 5-0. There were no written or oral comments. Rodgers moved to close Public Hearing at 6:10 pm. Second by McGuire, passed 5-0.

Rodgers moved to pass Resolution #0030121-01, Adopting City Budget for fiscal year July 1, 2021 through June 30, 2022. Second by Schneider, passed 5-0.

Sexton moved to pass Resolution #0030121-02, Approving Acquisition Plat for the City of Riverside at 40 E 2nd Street. Second by McGuire, passed 5-0.

Sexton moved to pass Resolution #030121-03, Approving the application to the Riverboat Foundation from the Fire Dept. for a new Thermal Imaging Camera. Second by McGuire, passed 5-0.

McGuire moved to pass Resolution #030121-04, Approving the application to the Riverboat Foundation from RACC for improvements to the Dog Park in Hall Park. Second by Schneider, passed 5-0.

Council reviewed changes to Chapter 136, Sidewalk Regulations, in the City Code of Ordinances.

McGuire moved to approve the letter of "Request for Qualifications for Engineering Service" to be sent to area engineering firms. Second by Sexton, passed 5-0.

Yancey presented Admin's report and Community Center meeting update.

Council discussed the basketball court in Hall Park.

McGuire moved to enter into closed session, per Iowa Code Chapter 21.5 (j) Real Estate, at 6:55 pm. Second by Sexton, passed 5-0.

Council returned to open meeting at 7:04 pm.

Rodgers moved to proceed as directed in closed session. Second by Schneider, passed 5-0.

McGuire moved to set the Public Hearing for the sale of City property at 40 E 2nd Street for \$124,000 at the March 15th Council Meeting, which begins at 6:00 pm in the Riverside Fire Station. Second by Rodgers, passed 5-0.

Redlinger moved to adjourn at 7:19 pm. Second by McGuire, passed 5-0.

Full content of Council Meetings can be viewed on the City web site; riversideiowa.gov

Council Meeting – Monday, March 15th, 2021 at 6:00 p.m. in Fire Station.

ATTEST:



Becky LaRoche; City Clerk

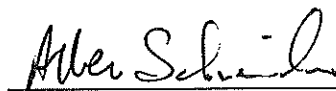

Allen Schneider; Mayor

EXPENDITURES 03-15-2021					
COUNCIL MEETING		UNPAID BILLS:			
1	ALLIANT ENERGY	PARKS	001-5-430-6371	\$	271.32
2	ALLIANT ENERGY	SEWER	610-5-815-6371	\$	1,051.58
3	ALLIANT ENERGY	CITY HALL	001-5-650-6371	\$	254.28
4	ALLIANT ENERGY	WATER	600-5-810-6371	\$	201.39
5	ALLIANT ENERGY	STREET LIGHTS	001-5-230-6371	\$	1,325.11
6	ALLIANT ENERGY	FIRE STATION	002-5-150-6330	\$	607.99
7	BECKY LaROCHE	MILEAGE- COURT HOUSE	001-5-650-6240	\$	21.28
8	BILLION AUTO	08 SILVERADO SENSOR	110-5-210-6331	\$	375.50
9	IMPERIAL AUTOMOTIVE	SKID LOADER TIRES	110-5-210-6331	\$	872.00
10	IOWA SOLUTIONS	RVFD-DOOR SWITCH	002-5-150-6310	\$	652.50
11	IOWA SOLUTIONS	SERVICE	001-5-650-6497	\$	433.30
12	JOHNSON COUNTY REFUSE	SERVICE	670-5-840-6499	\$	7,223.25
13	KALONA AUTO	SHOP	001-5-430-6325	\$	360.94
14	KCTC	RVFD	002-5-150-6332	\$	39.98
15	LEAF	COPIER LEASE	001-5-650-6496	\$	156.50
16	MEARDON SUEPPEL & DOWNER	LEGAL	001-5-640-6411	\$	850.00
17	MENARDS	SHOP	001-5-210-6372	\$	43.86
18	MIDWEST ALARM	FD DOORS	002-5-150-6310	\$	3,923.50
19	OFFICE EXPRESS	SUPPLY	001-5-650-6506	\$	130.16
20	OVERHEAD DOOR	RVFD	002-5-150-6310	\$	1,041.00
21	REC	SIGN	001-5-520-6510	\$	64.87
22	REC	LIFT STATION	610-5-815-6371	\$	88.00
23	REC	WW PLANT	610-5-815-6371	\$	3,490.40
24	REC	SHOP	001-5-210-6371	\$	45.42
25	REC	WATER PLANT	600-5-810-6371	\$	4,050.60
26	REC	TRAFIC LIGHT	001-5-230-6371	\$	167.85
27	REC	CASINO L/S	610-5-815-6371	\$	229.50
28	RELION INSURANCE	FY20 AUDIT-RFVD	002-5-150-6320	\$	768.00
29	RELION INSURANCE	FY20 AUDIT-RFVD	002-5-150-6319	\$	140.00
30	RELION INSURANCE	FY20 AUDIT-STREETS	001-5-210-6402	\$	2,726.00
31	RIVERSIDE GRAIN	ICE MELT	110-5-210-6335	\$	58.08
32	STANDARD PEST CONTROL	SERVICE	001-5-650-6310	\$	60.00
33	THE NEWS	PUBLICATIONS	001-5-650-6402	\$	269.27
34	VERIZON	COLLECTORS	600-5-810-6373	\$	63.54
35	VISA	RVFD TRAINING X 2	002-5-150-6354	\$	1,585.00
36	VISA	RVFD POSTAGE	002-5-150-6352	\$	13.30
37	VISA	E-MAILS .GOV	001-5-650-6494	\$	22.09
38	VISA	OFFICE	001-5-650-6506	\$	95.64
39	VISA	USTREAM	001-5-650-6494	\$	99.00
40	WA CO RECORDER	SIDEWALK RELEASE	001-5-650-6401	\$	12.00
41	WIELE	RVFD TRUCK LINER PKG	002-5-150-6352	\$	150.00
42	WS WOODWORKS	RVFD WOOD FLOOR SEAL	002-5-150-6310	\$	117.50
43	*****	TOTAL BILLS		\$	34,151.50
44		PAID BILLS:			
45	IOWA DEPT OF REVENUE	IOWA WITHHOLDINGS - 2021-FEB		\$	725.00
46	IOWA DEPT OF REVENUE	IOWA SALES TAX - 2021-FRB		\$	751.00
47	IOWA DEPT OF REVENUE	IOWA WET TAX - 2021-FEB		\$	1,423.00
48	IPERS	CONTRIBUTIONS - 2021 FEB		\$	2,930.23
49	IRS	941 TAX DEPOSIT - 2021		\$	4,114.83
50	PAYROLL	PAYROLL - 2021 FEB		\$	14,321.88
51	1ST NAT'L BANK	FEB 21 "HSA"		\$	750.00
52	MEDIACOM	PHONE		\$	204.11
53	REFUND	WATER DEPOSIT		\$	39.10
54		TOTAL PAID BILLS		\$	25,259.15
55	*****	TOTAL EXPENDITURES		\$	59,410.65
56	GENERAL FUND			\$	7,408.89
57	FIRE DEPARTMENT			\$	9,038.77
58	ROAD USE FUND			\$	1,305.58
59	CASINO FUNDS			\$	-
60	DEBT SERVICE			\$	-
61	CAPITAL PROJECTS			\$	-
62	WATER FUND			\$	4,315.53
63	SEWER FUND			\$	4,859.48
64	GARBAGE			\$	7,223.25
65	TOTAL EXPENDITURES			\$	34,151.50
66					
67					

68					
69					
70	MTD TREASURERS REPORT	2/28/2021	REVENUES	EXPENSES	BALANCE
71	GENERAL FUND		\$ 2,649.91	\$ 36,620.07	\$ 511,647.74
72	FIRE DEPT FUND		\$ 302.00	\$ 1,785.38	\$ 166,347.74
73	ROAD USE TAX FUND		\$ 8,679.15	\$ 4,315.42	\$ 51,781.73
74	LOCAL OPTION SALES TAX		\$ -	\$ -	\$ 210,265.68
75	CASINO REVENUE RUND		\$ 57,182.26	\$ -	\$ 334,807.29
76	DEBT SERVICE		\$ -	\$ -	\$ -
77	CAPITAL PROJECTS FUND		\$ -	\$ 6,448.73	\$ 55,787.81
78	COMMUNITY CENTER FUNDS		\$ 3,474.59	\$ -	\$ 1,023,485.68
79	WATER FUND		\$ 26,577.73	\$ 16,364.66	\$ 512,651.41
80	SEWER FUND		\$ 25,689.63	\$ 16,938.73	\$ 317,443.27
81	GARBAGE/LANDFILL FUND		\$ 7,302.57	\$ 6,973.75	\$ 10,092.94
82	STORM WATER FUND		\$ 1,569.27	\$ -	\$ 17,246.98
83	TOTAL		\$ 133,427.11	\$ 89,446.74	\$ 3,211,558.27

**RIVERSIDE FIRE
DEPARTMENT**

FIRE / RESCUE / EMS / HAZMAT



January/February 2021 Update

Calls for Service:

Medicals - 41
Structure Fires – 1
Motor Vehicle Accidents – 9
Other Fires (electrical, vehicle, alarms) – 5

Total calls – 56 calls for service in January and February

RFD responded to a mix of calls for the 2 month period, the call volume continues to be steady and increasing. RFD is averaging almost a call a day for 2021 if this pace keeps up we will run 100 to 130 more calls in 2021 than 2020.

Training:

The members trained on Grain Bin Rescue, this class was provided by the Iowa Fire Service Training Bureau and NEICC community college. This class put members in actual grain entrapment prop that they had to use our equipment to perform rescues. The members also trained on the new radios for Washington County. The training in January covered rope rescue skills and winter operations.

RESA:

The members worked on new fundraising ideas for 2021, the group is working on another drive thru meal for spring of 2021 (April) more information to come on this.

Other News

The new EMS/Rescue truck was placed into service on February 13th, this truck has been a great addition to RFD and has made our response to calls more efficient. I will provide more info on the truck at the annual report meeting on March 15th. The new radio's and pager were delivered and placed into service on the new system for Washington County on March 1st. The Chief's have been working with the other Wash Co Chiefs and EMS on standard operations of the system and dispatch to improve communications. The next need for emergency response in Washington County is an upgrade to the Computer Aided Dispatch system or CAD. This upgrade would be a specific module and software for Fire/EMS. The current system was purchased by Law and is tailored to them. This new software would increase the effectiveness of emergency response for FIRE/EMS. I am told this is a 911 Communications issue which the Riverside City Council is a part of that commission.

“WE”RE STILL HERE AND READY TO RESPOND”

Thanks

Chief Smothers

WASHINGTON COUNTY SHERIFF'S OFFICE Town Report

Filter: datestart=20210201:dateend=20210228:Zone=CRIV

<u>Date/Time</u>	<u>CFS</u>	<u>Call Type</u>	<u>Zone</u>
02/01/2021 08:06:44	2101267	ALARM	CRIV
<p><u>Agency:</u> Washington County Sheriff's Office</p> <p><u>Address:</u> 90 E RAILROAD ST</p> <p><u>City/State/Zip:</u> RIVERSIDE, IA 52327</p> <p><u>details:</u> [02/01/2021 08:08:18] REPORTS AN ALARM.</p>			
02/04/2021 11:33:19	2101370	TRAFFIC-ACCIDENT	CRIV
<p><u>Agency:</u> EMS</p> <p><u>Address:</u> E 1ST ST&E HICKORY ST</p> <p><u>City/State/Zip:</u> RIVERSIDE, IA 52327</p> <p><u>details:</u> [02/04/2021 12:27:32] Mileage report: Unit 92-10 traveled to destination: CASEYS Date/time: 2/4/2021 12:23:21 PM to 2/4/2021 12:27:32 PM Odometer Reading: 83652.1 to 83653 Mileage = 0.9 [02/04/2021 11:36:58] CALLER REPORTS A TRAFFIC ACCIDENT. 92-10, AD54, AD55, AD57, IHP, RIVERSIDE FIRE DEPARTMENT AND RIVERSIDE QRS RESPONDED. NO TRANSPORT. LIC/JCG991 OPR/MILEWSKI, WAVERLY MAE KUHNENN ADDRESS/420 N RAILROAD ST AINSWORTH, IA VS LIC/AJB664 OPR/PUTNAM,CLAUDIA WOODS ADDRESS/2463 JASPER AVE LETTS, IA. STATE ACCIDENT REPORT TO BE FILED.</p>			
02/04/2021 12:15:17	2101376	DRUG/NARCOTICS VIOLATION	CRIV
<p><u>Agency:</u> Washington County Sheriff's Office</p> <p><u>Address:</u> 3184 HIGHWAY 22</p> <p><u>City/State/Zip:</u> RIVERSIDE, IA 52327</p> <p><u>details:</u> [02/04/2021 13:09:53] Linked to CFS#: 2101372 [02/04/2021 11:50:37] REPORTS A FEMALE SUBJECT IN POSSESSION OF DRUGS. REQUESTING A DEPUTY.</p>			

WASHINGTON COUNTY SHERIFF'S OFFICE Town Report

Filter: datestart=20210201:dateend=20210228:Zone=CRIV

92-10 RESPONDED. UNFOUNDED.

02/05/2021 15:15:05 2101461 SEX OFFENDER-REGISTR ACTION CRIV

Agency: Washington County Sheriff's Office

Address: 111 E 4TH ST

City/State/Zip: RIVERSIDE, IA 52327

details:

[02/05/2021 15:18:27]
CALLER REPORTS A NEW SEX OFFENDER REGISTRY. NAM/EVANS,WILLIAM WALTER ADR/111 E 4TH ST, RIVERSIDE
02/07/2021 05:14:36 2101525 SUSPICIOUS CRIV
ACTIVITY

Agency: Washington County Sheriff's Office

Address: 3184 HIGHWAY 22

City/State/Zip: RIVERSIDE, IA 52327

details:

[02/07/2021 05:17:26]
CALLER REPORTS FINDING A SUSPICIOUS ITEM AT THE CASINO AND WOULD LIKE A DEPUTY TO LOOK AT IT. 92-9 RESPONDED.
REPORT TO BE FILED.

02/07/2021 06:21:53 2101526 SUSPICIOUS CRIV
ACTIVITY

Agency: Washington County Sheriff's Office

Address: 31 E 3RD ST

City/State/Zip: RIVERSIDE, IA 52327

details:

[02/07/2021 06:22:59]
REPORTS A HUGE BANG THAT WOKE HER UP.

92-8 RESPONDED AND WAS UNABLE TO LOCATE ANYTHING.

02/07/2021 13:54:25 2101539 PUBLIC CRIV
INTOXICATION

Agency: Washington County Sheriff's Office

Address: 3184 HIGHWAY 22

WASHINGTON COUNTY SHERIFF'S OFFICE Town Report

Filter: datestart-20210201:dateend-20210228:Zone-CRIV

City/State/Zip: RIVERSIDE, IA 52327

details:

[02/07/2021 13:55:39]
REPORTS AN INTOXICATED SUBJECT IS REFUSING TO LEAVE, HE IS BY THE HOTEL DESK.

02/08/2021 12:27:27 2101567 92-8 RESPONDED. SUBJECT GOT A RIDE.
TRAFFIC-DRIVING CRIV
COMPLAINT

Agency: Washington County Sheriff's Office

Address: 3021 HIGHWAY 22

City/State/Zip: RIVERSIDE, IA 52327

details:

[02/08/2021 12:31:43]
REPORTS HE IS BEHIND A RED JEEP CHEROKEE EAST OF RIVERSIDE, LIC/FNN760. VEHICLE PULLED INTO DOLLAR GENERAL.
92-16 AND T-113 RESPONDED. SUBJECT WAS TRANSPORTED TO THE WASHINGTON COUNTY JAIL FOR FURTHER TESTING.
T-113 ARRESTED: BAUMGARTEL, MARK ALAN (41) OF 714 A AVE, KALONA. OFF/OWI 1ST AND INTERFERENCE WITH OFFICIAL ACTS.
ALARM CRIV

02/09/2021 00:08:38 2101593

Agency: Washington County Sheriff's Office

Address: 3070 HIGHWAY 22

City/State/Zip: RIVERSIDE, IA 52327

details:

[02/09/2021 00:11:10]
CALLER REPORTS A COMMERCIAL BURGLARY ALARM. 92-9 RESPONDED. ALL DOORS WERE SECURE AND A KEYHOLDER ARRIVED ON
SCENE. EVERYTHING WAS FINE.

02/09/2021 23:55:51 2101631 PROPERTY-RECOVER CRIV
ED

Agency: Washington County Sheriff's Office

Address: 3175 HIGHWAY 22

City/State/Zip: RIVERSIDE, IA 52327

details:

[02/09/2021 23:59:05]
DEPUTY REPORTS BEING OUT WITH A GOLD LINCOLN TOWN CAR BEARING STOLEN LICENSE PLATES JCL272. 92-20 REMOVED THE
PLATES. CHARGES TO BE FILED ON NAMM/WREDE, LARRY JUDGE AGE/79 ADR/3175 HIGHWAY 22 LOT 11, RIVERSIDE FOR FRAUDULENT
USE OF LICENSE PLATES.
PLATES CLEARED FROM THE SYSTEM. OCA/2011929

WASHINGTON COUNTY SHERIFF'S OFFICE Town Report

Filter: datestart-20210201:dateend-20210228:Zone-CRIV

02/10/2021 00:10:09 2101632 WARRANT ARREST CRIV

Agency: Washington County Sheriff's Office

Address: 3175 HIGHWAY 22

City/State/Zip: RIVERSIDE, IA 52327

details:

[02/10/2021 00:50:46]

Mileage report: Unit 92-20 traveled to destination: L & D^{MS}
Date/time: 2/10/2021 12:30:23 AM to 2/10/2021 12:50:46 AM
Odometer Reading: 46448 to 46467
Mileage = 19

[02/10/2021 00:10:57]
DEPUTY REPORTS BEING OUT WITH A SUBJECT WANTED OUT OF LOUISA COUNTY. 92-20 ARRESTED NAMMREDE, LARRY JUDGE
AGE 79 ADR/3175 HIGHWAY 22 LOT 11, RIVERSIDE OFFENSE/FAILURE TO APPEAR PTC FOR DRIVING UNDER SUSPENSION BOND IS
\$500 CASH ONLY. SUBJECT TRANSPORTED TO THE LOUISA COUNTY LINE AND TURNED OVER TO 58-8.

02/10/2021 22:31:30 2101663 ALL OTHER CRIV
OFFENSES

Agency: Washington County Sheriff's Office

Address: 3184 HIGHWAY 22

City/State/Zip: RIVERSIDE, IA 52327

details:

[02/10/2021 22:37:34]

CALLER REQUESTS ASSISTANCE WITH A PATRON WHO IS INTOXICATED AND REFUSING TO LEAVE THE PREMESIS. 92-20 RESPONDED
AND ASSISTED SUBJECT IN CONTACTING AN UBER.

02/11/2021 14:51:18 2101688 SEARCH WARRANT CRIV

Agency: Washington County Sheriff's Office

Address: 3184 HIGHWAY 22

City/State/Zip: RIVERSIDE, IA 52327

details:

[02/11/2021 14:51:45]

92-11 REPORTS A SEARCH WARRANT. 92-3 ALSO RESPONDED. SEARCH WARRANT EXECUTED. REPORT TO BE FILED. PENDING
CHARGES PER DCI LAB RESULTS FOR POSSESSION OF DRUG PARAPHERNALIA, POSSESSION OF CONTROLLED SUBSTANCE 3RD AND
SUBSEQUENT - METHAMPHETAMINE, AND DISORDERLY CONDUCT.

02/11/2021 16:24:28 2101694 FRAUD CRIV

Agency: Washington County Sheriff's Office

WASHINGTON COUNTY SHERIFF'S OFFICE

Town Report

Filter: datestart-20210201:dateend-20210228:Zone-CRIV

Address: 120 RAILROAD ST

City/State/Zip: RIVERSIDE, IA 52327

details:

[02/11/2021 16:26:44]
CALLER REQUESTS TO SPEAK TO A DEPUTY REFERENCE A SCAM PHONE CALL WHERE THEY DID PROVIDE THEIR INFORMATION.
92-19 SPOKE WITH THE CALLER. THEY WERE ADVISED OF THEIR OPTIONS. DOCUMENTATION.

02/11/2021 16:53:50 2101696 TRAFFIC-PARKING CRIV
COMPLAINT

Agency: Washington County Sheriff's Office

Address: 31 W 2ND ST

City/State/Zip: RIVERSIDE, IA 52327

details:

[02/24/2021 09:19:31]
Linked to CFS#: 2102119
[02/12/2021 09:30:14]
Linked to CFS#: 2101721
[02/11/2021 16:54:30]

CALLER REQUESTS A DEPUTY CHECK ON TWO VEHICLES. A GREEN SILVERADO PARKED ON 3RD ST BETWEEN WASHBURN AND GLASGOW THAT HAS NOT MOVED ALL WINTER AND A SILVER SAAB NEAR 31 W 2ND ST PARKED ON THE NO PARKING SIDE OF THE STREET. 92-19 RESPONDED. THE OWNER OF THE GREEN TRUCK WAS ADVISED TO GET THE VEHICLE MOVED OR IT WILL HAVE TO BE TOWED. THE SILVER SAAB WAS NO LONGER THERE.

*2/24/21: 92-17 REQUESTED EARLS TO TOW THE VEHICLE. VEHICLE ENTERED AS TOWED. SIN/3108985 RELEASE WHEN TOW BILL PAID AND VALID REGISTRATION.

02/11/2021 17:51:12 2101703 SEARCH WARRANT CRIV

Agency: Washington County Sheriff's Office

Address: 3184 HIGHWAY 22

City/State/Zip: RIVERSIDE, IA 52327

details:

[02/11/2021 17:51:50]
DEPUTIES REPORT CONDUCTING A SEARCH WARRANT. SEARCH WARRANT EXECUTED. DOCUMENTATION.

02/12/2021 09:05:03 2101721 TRAFFIC-PARKING CRIV
COMPLAINT

Agency: Washington County Sheriff's Office

Address: 80 W 2ND ST

City/State/Zip: RIVERSIDE, IA 52327

WASHINGTON COUNTY SHERIFF'S OFFICE Town Report

Filter: datestart=20210201:dateend=20210228:Zone=CRIV

details:

[02/12/2021 09:06:09]
92-17 REQUESTS EARLS TOWING TO TOW A VEHICLE THAT HAS NOT MOVED IN DAYS FROM 80 W 2ND ST., IN RIVERSIDE. VEHICLE HAS A FLAT TIRE. LIC/JMT330 SIN/3106150 OCA/2101721 VEHICLE CAN BE RELEASED WHEN TOW BILL PAID.

*2/17/21: VEHICLE CLEARED FROM THE SYSTEM.

02/12/2021 22:15:42 2101742 TRAFFIC CRIV
STOP-INTOXICATED
DRIVER

Agency: Washington County Sheriff's Office

Address: 1092 WALNUT AVE

City/State/Zip: RIVERSIDE, IA 52327

details:

[02/12/2021 22:16:48]
VEHICLE STOP WITH LIC/CHK156. 92-14 AND ISP 77 ALSO RESPONDED. ARRESTED NAMEDWARDS, BRYAN LEE AGE/52 ADR/206 W ELM ST LONE TREE, IA OFFENSE/OW 2ND OFFENSE AND DUS X1

SUBJECT ALSO WANTED OUT OF JOHNSON COUNTY OFFENSE/FAILURE TO APPEAR FOR ARRAIGNMENT ON ORIGINAL CHARGE OF OW 1ST OFFENSE. BOND/\$1,000 CASH OR SURETY.

02/12/2021 22:29:00 2101745 BURGLARY-BUSINES CRIV
S

Agency: Washington County Sheriff's Office

Address: 3078 HIGHWAY 22

City/State/Zip: RIVERSIDE, IA 52327

details:

[02/12/2021 23:02:22]
DEPUTY REPORTS BEING AT THE RIVERSIDE AUTO SPA WITH POTENTIAL DAMAGE. 92-14 SPOKE WITH THE OWNER. NO NEW DAMAGE.

02/13/2021 03:22:06 2101748 VANDALISM-CRIMINA CRIV
L MISCHIEF

Agency: Washington County Sheriff's Office

Address: 3184 HIGHWAY 22

City/State/Zip: RIVERSIDE, IA 52327

details:

[02/13/2021 03:24:27]

WASHINGTON COUNTY SHERIFF'S OFFICE

Town Report

Filter: datestart-20210201:dateend-20210228:Zone-CRIV

02/14/2021 09:34:40 2101784 ASSAULT-DOMESTIC - CRIV
CALLER REPORTS HIS TRUCK HAS BEEN VANDALIZED. 92-9 AND 92-19 RESPONDED. DOCUMENTATION AT THIS TIME.

Agency: Washington County Sheriff's Office

Address: 91 W2ND ST

City/State/Zip: RIVERSIDE, IA 52327

details:

[02/14/2021 09:34:40]
Cloned From Parent: 2101783 with Call Type: MEDICAL CALL

[02/14/2021 09:33:48]

CALLER REPORTS SHE JUST ESCAPED FROM HER HOUSE. HER HUSBAND KEPT HER LOCKED INSIDE ALL NIGHT. SUBJECT REPORTS SHE LEFT OUT HER SONS WINDOW. HER THREE KIDS REMAIN INSIDE THE HOUSE WITH HER HUSBAND. 92-8 RESPONDED AND SPOKE WITH ALL PARTIES INVOLVED. 92-8 CONDUCTED A CIVIL STANDBY WHILE THE FEMALE SUBJECT GRABBED SOME OF HER ITEMS. CONFLICTING STORIES AND PARTIES SEPARATED. DOCUMENTATION.

02/15/2021 16:26:52 2101823 SEX OFFENDER-CHECK CRIV

Agency: Washington County Sheriff's Office

Address: 41 N GREENE ST

City/State/Zip: RIVERSIDE, IA 52327

details:

[02/15/2021 16:27:16]

S.O.R. CHECK NOT PRESENT.

02/15/2021 17:52:56 2101827 TRAFFIC STOP-SERIOUS CRIV

Agency: Washington County Sheriff's Office

Address: 3021 HIGHWAY 22

City/State/Zip: RIVERSIDE, IA 52327

details:

[02/15/2021 17:53:23]

DEPUTY REPORTS A VEHICLE STOP AT THE DOLLAR GENERAL IN RIVERSIDE WITH A BEIGE LINCOLN TOWN CAR WITH NO PLATES. 92-14 ARRESTED NAM/WREDE, LARRY JUDGE AGE/79 ADR/3175 HIGHWAY 22 LOT 11, RIVERSIDE OFFENSE/DRIVING WHILE BARRED. CITED FOR NO INSURANCE AND IMPROPER REGISTRATION. VEHICLE TOWED AND ENTERED SIN/3106812

*2/23/21: VEHICLE CLEARED FROM THE SYSTEM.

02/15/2021 19:01:14 2101829 INTIMIDATION/HARAS CRIV
SMENT

Agency: Washington County Sheriff's Office

WASHINGTON COUNTY SHERIFF'S OFFICE Town Report

Filter: datestart=20210201:dateend=20210228:Zone=CRIV

Address: 102 KLEOPFER AVE

City/State/Zip: RIVERSIDE, IA 52327

details:

[02/15/2021 19:04:06]
CALLER REPORTS HER EX WAS AT THE RESIDENCE TRYING TO GET IN AND DAMAGED HER VEHICLE WHEN HE LEFT. 92-15 ADVISED DOCUMENTATION.

02/17/2021 02:52:09 2101884 TRAFFIC-DISABLED CRIV
VEHICLES

Agency: Washington County Sheriff's Office

Address: COMMERCIAL DR&HIGHWAY 22

City/State/Zip: RIVERSIDE, IA 52327

details:

[02/17/2021 22:24:25]
Type of Call Changed from TRAFFIC STOP to TRAFFIC-DISABLED VEHICLES by Parish, Delaine

[02/17/2021 02:52:46]

92-9 REPORTS BEING OUT WITH VEHICLE IN THE TURN LANE.

02/17/2021 02:59:36 2101885 TRAFFIC-DISABLED CRIV
VEHICLES

Agency: Washington County Sheriff's Office

Address: VINE AVE&HIGHWAY 22

City/State/Zip: RIVERSIDE, IA

details:

[02/18/2021 10:57:06]

Linked to CFS#: 2101936

[02/17/2021 03:00:12]

92-9 REPORTS BEING OUT WITH A DISABLED VEHICLE. ADDED TO MACH.

02/17/2021 14:30:23 2101904 SEX CRIV
OFFENDER-REGISTR
ATION

Agency: Washington County Sheriff's Office

Address: 41 N GREENE ST

City/State/Zip: RIVERSIDE, IA 52327

details:

[02/17/2021 14:31:54]
REPORTS CONDUCTING A SEX OFFENDER VERIFICATION.

WASHINGTON COUNTY SHERIFF'S OFFICE Town Report

Filter: datestart=20210201:dateend=20210228:Zone=CRIV

02/18/2021 00:38:39 2101928 VERIFICATION WAS COMPLETED. CRIV
FAMILY OFFENSE
NON-VIOLENT

Agency: Washington County Sheriff's Office

Address: 3184 HIGHWAY 22

City/State/Zip: RIVERSIDE, IA 52327

details:

[02/18/2021 00:42:29]
CALLER REPORTS HAVING PROBLEMS WITH HIS EX FIANCE, SHE IS TRYING TO LEAVE CASINO IN HER CAR AND SHE IS INTOXICATED.
92-20 AND 92-15 RESPONDED. CALLER AND FEMALE SEPARATED AND IN THEIR OWN ROOMS FOR THE NIGHT.

02/18/2021 07:53:51 2101931 INTIMIDATION/HARAS CRIV
SMENT

Agency: Washington County Sheriff's Office

Address: 91 W2ND ST

City/State/Zip: RIVERSIDE, IA 52327

details:

[02/19/2021 10:53:05]

[02/18/2021 07:55:28]
REPORTS HER HUSBAND IS SENDING HER SUICIDAL TEXT MESSAGES. HE HAS THE KIDS. REQUEST TO SPEAK WITH A DEPUTY.

SPOKE WITH BOTH SUBJECTS. HE HAS NO INTENTION OF HURTING HIMSELF. HE WAS ADVISED THAT IF HE CONTINUES TO TEXT THE CALLER, HE COULD BE CHARGED WITH HARASSMENT. HE WAS GIVEN OTHER OPTIONS.

ONE ITEM CONFISCATED AND WILL BE DESTROYED. REPORT TO BE FILED.

02/18/2021 19:15:33 2101955 TRESPASS CRIV

Agency: Washington County Sheriff's Office

Address: 3184 HIGHWAY 22

City/State/Zip: RIVERSIDE, IA 52327

details:

[02/18/2021 19:17:27]
CALLER REQUESTS A DEPUTY FOR ASSISTANCE WITH BANNING A SUBJECT. 92-19 RESPONDED. THE SUBJECT WAS BANNED FROM THE PROPERTY.

02/19/2021 19:20:06 2101995 INTIMIDATION/HARAS CRIV
SMENT

Agency: Washington County Sheriff's Office

WASHINGTON COUNTY SHERIFF'S OFFICE Town Report

Filter: datestart-20210201:dateend-20210228:Zone-CRIV

Address: 3184 HIGHWAY 22

City/State/Zip: RIVERSIDE, IA 52327

details:

[02/19/2021 20:35:31]

CALLER REQUESTS TO SPEAK TO A DEPUTY REFERENCE HARASSMENT. 92-19 SPOKE WITH THE CALLER. THEY WERE GIVEN THEIR OPTIONS.

02/20/2021 16:00:58 2102025 TRAFFIC-DRIVING COMPLAINT CRIV

Agency: Washington County Sheriff's Office

Address: W 1ST ST&N BOISE ST

City/State/Zip: RIVERSIDE, IA 52327

details:

[02/20/2021 16:18:00]

CALLER REPORTS SNOWMOBILERS RIDING IN THE ROADWAY. 92-11 WAS ADVISED. DOCUMENTATION.

02/22/2021 00:16:11 2102069 TRAFFIC STOP-INTOXICATED DRIVER CRIV

Agency: Washington County Sheriff's Office

Address: S WASHINGTON ST&W 1ST ST

City/State/Zip: RIVERSIDE, IA 52327

details:

[02/22/2021 06:56:34]

Type of Call Changed from TRAFFIC STOP to TRAFFIC STOP-INTOXICATED DRIVER by Salemk, Sean

[02/22/2021 00:17:42]

92-9 REPORTS A TRAFFIC STOP. 92-14 ALSO RESPONDED. ARRESTED NAM/GOTTSCHALK, JOE ALLEN (41) ADR/210 E JAYNE ST, LONE TREE IA 52755 OFFENSE/DRIVING UNDER THE INFLUENCE SECOND OFFENSE. A FAMILY MEMBER TOOK POSSESSION OF THE VEHICLE.

02/22/2021 01:25:56 2102070 TRESPASS CRIV

Agency: Washington County Sheriff's Office

Address: 21 W 1ST ST

City/State/Zip: RIVERSIDE, IA 52327

details:

[02/22/2021 01:39:29]

CALLER REPORTS A SUBJECT IS IN THE HOUSE AND WONT LEAVE. SUBJECT LEFT BEFORE 92-14 ARRIVED. DOCUMENTATION.

02/22/2021 12:23:12 2102085 TRAFFIC-PARKING CRIV

WASHINGTON COUNTY SHERIFF'S OFFICE Town Report

Filter: datestart-20210201:dateend-20210228:Zone-CRIV

COMPLAINT

Agency: Washington County Sheriff's Office

Address: N GLASGOW ST&W 2ND ST

CityStateZip: RIVERSIDE, IA 52327

details:

[02/22/2021 12:24:07]
REPORTS 3 VEHICLES PARKED IN BETWEEN NO PARKING SIGNS.

92-10 RESPONDED. PLACED 24 TOW TAGS ON VEHICLES.

*2/23/21: 92-8 ADVISED ALL 3 VEHICLES HAD BEEN MOVED.

02/22/2021 13:07:00 2102087 TRAFFIC-PARKING CRIV
COMPLAINT

Agency: Washington County Sheriff's Office

Address: 36 N WASHBURN ST

CityStateZip: RIVERSIDE, IA 52327

details:

[02/22/2021 13:07:40]
92-10 REPORTS BEING OUT WITH A VEHICLE PARKED IN THE WRONG AREA. 92-10 SPOKE WITH THE OWNER OF THE VEHICLE AND
THEY ARE GOING TO GET IT MOVED.

02/22/2021 14:59:37 2102090 SEX CRIV
OFFENDER-REGISTR
ATION

Agency: Washington County Sheriff's Office

Address: 36 N WASHBURN ST

CityStateZip: RIVERSIDE, IA 52327

details:

[02/22/2021 15:00:40]
CALLER REPORTS A SEX OFFENDER VERIFICATION THAT OCCURRED AT 1045 THIS MORNING AT THE SHERIFFS OFFICE.

DOCUMENTATION.

02/23/2021 04:38:48 2102109 DRUG/NARCOTICS CRIV
VIOLATION

Agency: Washington County Sheriff's Office

Address: 3184 HIGHWAY 22

CityStateZip: RIVERSIDE, IA 52327

Date Printed: 3/2/2021 9:55 AM

WASHINGTON COUNTY SHERIFF'S OFFICE Town Report

Filter: datestart-20210201:dateend-20210228:Zone-CRIV

details:

[02/23/2021 04:42:56]
CALLER REPORTS WITNESSING ILLEGAL ACTIVITY IN THE PARKING LOT OF THE CASINO. 92-9 RESPONDED. DOCUMENTATION AT THE TIME.

02/23/2021 09:16:01 2102117 SEX OFFENDER-REGISTRATION CRIV

Agency: Washington County Sheriff's Office

Address: 120 N KNISEL ST

City/State/Zip: RIVERSIDE, IA 52327

details:

[02/23/2021 09:16:55]
REPORTS A SEX OFFENDER VERIFICATION.

02/23/2021 10:02:57 2102119 DOCUMENTATION. TRAFFIC-PARKING COMPLAINT CRIV

Agency: Washington County Sheriff's Office

Address: E 3RD ST&N ELLA ST

City/State/Zip: RIVERSIDE, IA 52327

details:

[02/24/2021 09:19:31]
Linked to CFS#: 2101696
[02/23/2021 10:03:44]
REPORTS A GREEN CHEVY SILVERADO HAS BEEN PARKED ON THE STREET FOR QUITE SOME TIME WITHOUT MOVING.

02/23/2021 12:33:32 2102127 92-8 RESPONDED. NO PLATES AND UNABLE TO READ ALL THE CHARACTERS ON THE VIN. WILL TRY TO CONTACT THE OWNER. ANIMAL-DOGS AT LARGE CRIV

Agency: Washington County Sheriff's Office

Address: 141 W 3RD ST

City/State/Zip: RIVERSIDE, IA 52327

details:

[02/23/2021 12:42:28]
CALLER REPORTS A GERMAN SHEPHERD LUNGED AT HER AND HER DOG WHILE SHE WAS IN HER YARD. REQUESTS TO SPEAK TO AN OFFICER. 92-8 RESPONDED AND SPOKE WITH THE OWNER OF THE DOG AND THEY WERE MADE AWARE OF THE COMPLAINT.

WASHINGTON COUNTY SHERIFF'S OFFICE Town Report

Filter: datestart-20210201:dateend-20210228:Zone-CRIV

02/25/2021 05:16:57 2102201 DOCUMENTATION:
FAMILY OFFENSE CRIV
NON-VIOLENT

Agency: Washington County Sheriff's Office

Address: 3184 HIGHWAY 22

City/State/Zip: RIVERSIDE, IA 52327

details:

[02/25/2021 05:18:23]

CALLER REPORTS THERE ARE TWO SUBJECTS IN THE PARKING LOT ARGUING. 92-9 RESPONDED. PARTIES AGREED TO REMAIN CIVIL.

MOMENTS LATER 92-9 WAS CALLED BACK TO THE SCENE FOR THE SAME ISSUE.

02/27/2021 11:30:47 2102302 SUSPICIOUS CRIV
ACTIVITY

Agency: Washington County Sheriff's Office

Address: 3184 HIGHWAY 22

City/State/Zip: RIVERSIDE, IA 52327

details:

[02/27/2021 11:32:16]

REPORTS A SILVER DODGE NEON WITH NO PLATES HAS A MALE SUBJECT SITTING IN IT, IN THE PARKING LOT. CALLER SPOKE WITH HIM AND HE WAS ACTING SUSPICIOUS. REQUEST A DEPUTY.

92-8 SPOKE WITH THE SUBJECT WHO IS WAITING FOR HIS WIFE. NO PROBLEM WITH THE SUBJECT OR THE VEHICLE.

02/28/2021 17:36:23 2102355 WELFARE CHECK CRIV

Agency: EMS

Address: 340 E 3RD ST

City/State/Zip: RIVERSIDE, IA 52327

details:

[02/28/2021 17:38:53]

CALLER REQUESTS A WELFARE CHECK. RIVERSIDE QRS, AD57 AND 92-10 RESPONDED. AD57 AND 92-10 WERE DISREGARDED BY RIVERSIDE QRS UPON ARRIVAL. NO TRANSPORT DUE TO PATIENT REFUSAL. THE CALLER WAS ADVISED.



**Saturday April 10th
3:00**

Registration and Start Line at Railroad (purple) Park

Price \$20 per person, Maximum \$50 per Household
Make Checks payable to Highland Post Prom or
Venmo @highlandpostprom
Pre Register by April 2nd

There will be 5 coloring stations along the approximately 2 mile route. This will not be timed so you can go back through coloring stations as many times as you would like, while supplies last.

All Participants will receive a Highland neck gaiter (can't be worn at school) and a pair of sunglasses. Goodies guaranteed to all the pre register. Registration form on the reverse side of this flier.

After you have been colored, join us at the Ballpark for music, popcorn and slushies.

Please socially distance yourself from others at the start of the race and along the course. You will WANT to wear your face covering along the route. Refunds will be issued if you can not attend due to illness.

Let's have some fun!

Highland Post Prom Event and Donation Request

The Highland High School Post-Prom Committee is planning an evening of safe and alcohol-free fun for the students after the Highland High School Prom to be held on April 17, 2021. Through the financial support of many area businesses and parents, it has been possible to provide this event as a successful collaborative project between school, family and the community.

We would like to host a Post Prom fundraising event in the City of Riverside. We would like to host a Color Run. A color run is a one of a kind experience that is less about speed and more about enjoying a color crazy afternoon with friends and family.

Registration and starting line will be located at Railroad Park, participants will walk or run the length of the trail and end at Railroad park. Along the route there will be 5 different "coloring stations". At each coloring station, volunteers will throw a safe non-toxic colored powder at participants. Most participants wear all white so that by the time they are through all of the coloring stations, they are covered in a rainbow of colors.

After everyone is through the route, we will host an after party at Hall Park. We will have music, popcorn and slushies for participants. Riverside Ball Association has agreed to allow us the use of their popcorn machine and slush machine for the event.

Traffic may be briefly interrupted at the corner of S. Hickory Street and River Street. We will plan to have a volunteer stationed at this intersection to make sure all participants are through the intersection if a vehicle comes along.

We will be asking local businesses to sponsor a color. We would like to ask the City of Riverside for a contribution of \$500 to sponsor the purchase of Highland neck gaiters to be given to participants. Participants will actually WANT to wear a face covering to keep the powder out of their mouth. Highland Post Prom is a non profit 501©(3) organization. Our tax identification number will be furnished as needed.

We can't plan an event right now without addressing COVID. As I stated earlier, participants will WANT to wear their face coverings along the route. They will be asked to socially distance themselves from participants outside of their home, however, this type of event naturally leads to social distancing. Since this event will be outside, there is a far lower risk of transmission of COVID compared to inside events. Participants will be asked to stay home if they are sick and will be issued a refund for illness. At the time of writing this, Washington County has a low 1.1% positivity rate. Considering all of these factors, I feel this event is low risk. I also feel that the community would benefit from a fun, safe, family friendly event.

I will plan to attend the March 15th, 2021 city council meeting to answer any questions you may have. I look forward to talking with you.

Thank you for your consideration,

Cindy Peiffer



RFD 2020
ANNUAL REPORT



RFD 2020 CALLS FOR SERVICE

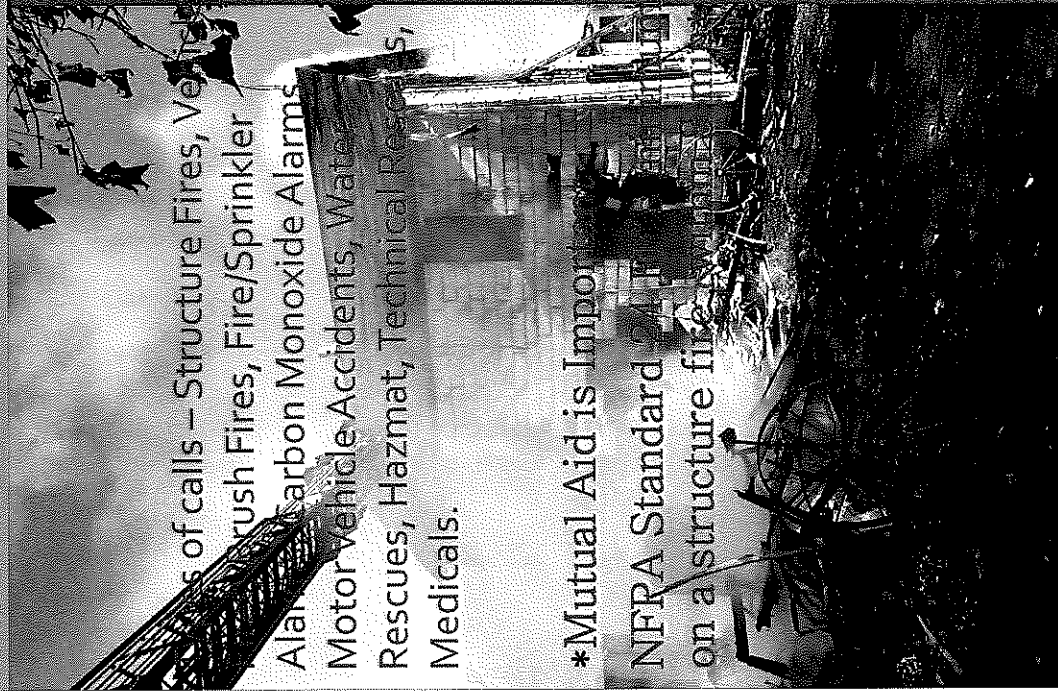

• Calls For Service

- Fires - 36
- MVA - 18
- EMS - 177
- Total - 231

Mutual Aid

- * Given - 22
- * Received - 6

• 2019 - 216

*Overlapping Calls - 12

• RFD responded on 23 building fires in 2020

Types of calls - Structure Fires, Vehicle Fires, Brush Fires, Fire/Sprinkler Alarm, Carbon Monoxide Alarms, Motor Vehicle Accidents, Water Rescues, Hazmat, Technical Rescues, Medicals.

*Mutual Aid is Important

NFPA Standard 2411
on a structure fire

CALLS FOR SERVICE

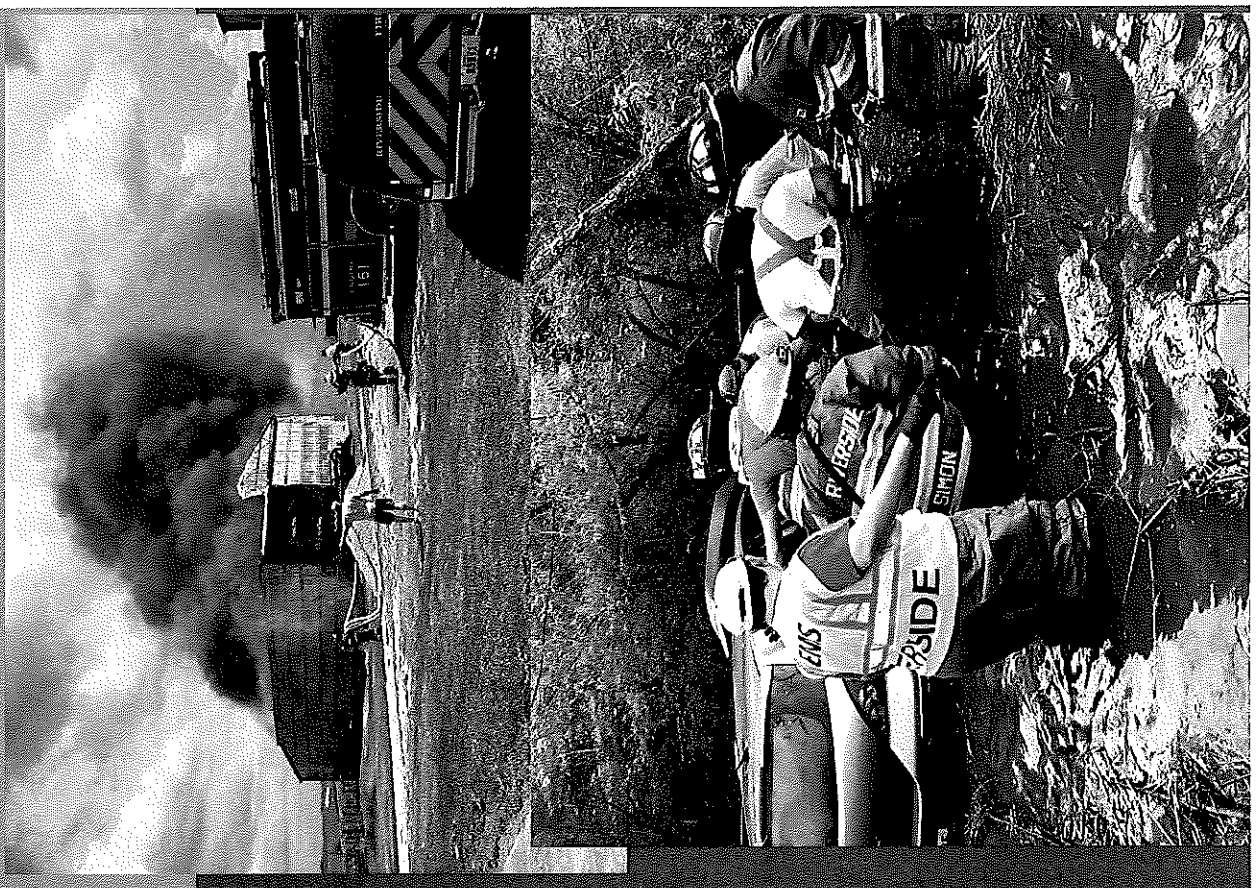
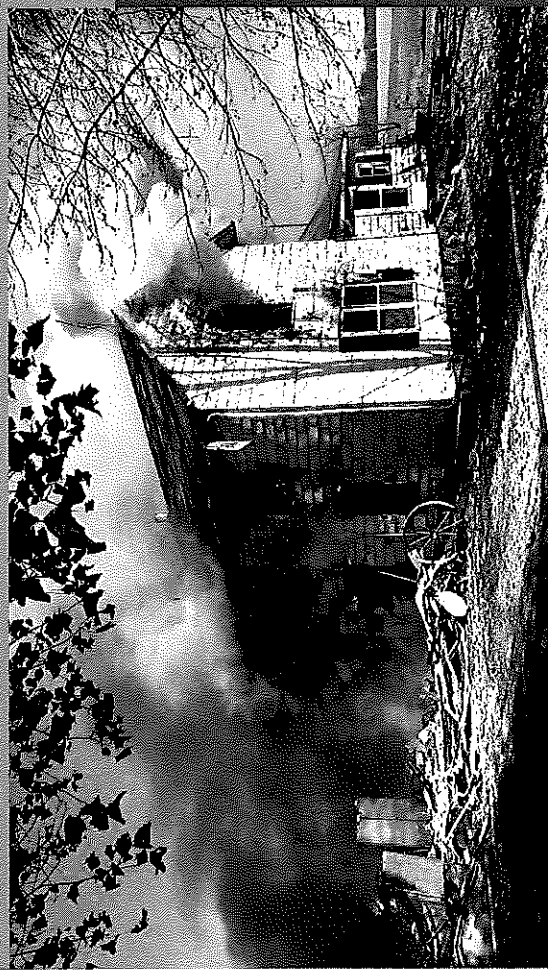

Riverside Volunteer Fire Department (IA)

Riverside, IA

This report was generated on 2/3/2021 11:14:55 AM



Riverside Volunteer Fire Department (IA)

Riverside, IA

This report was generated on 2/3/2021 11:18:37 AM

Incidents by Month for Month Range

Start Month: January | End Month: December | Year: 2020

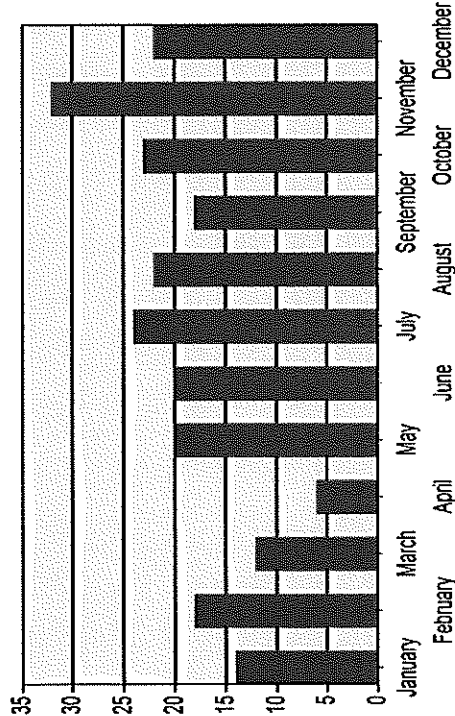

MONTH	INCIDENTS
January	14
February	18
March	12
April	6
May	20
June	20
July	24
August	22
September	18
October	23
November	32
December	22

Incident Type Count per Station for Date Range

Start Date: 01/01/2020 | End Date: 12/31/2020

INCIDENT TYPE	# INCIDENTS
Station: ST1 - STATION 1	
111 - Building fire	23
141 - Forest, woods or woodland fire	1
142 - Brush or brush-and-grass mixture fire	4
221 - Overpressure rupture of air or gas pipe/pipeline	1
311 - Medical assist, assist EMS crew	36
321 - EMS call, excluding vehicle accident with injury	105
322 - Motor vehicle accident with injuries	12
324 - Motor vehicle accident with no injuries.	6
341 - Search for person on land	1
411 - Gasoline or other flammable liquid spill	1
412 - Gas leak (natural gas or LPG)	1
445 - Arcing, shorted electrical equipment	1
552 - Police matter	1
553 - Public service	1
554 - Assist invalid	3
600 - Good intent call, other	7
611 - Dispatched & cancelled en route	11
700 - False alarm or false call, other	1
731 - Sprinkler activation due to malfunction	1
733 - Smoke detector activation due to malfunction	1
736 - CO detector activation due to malfunction	1
900 - Special type of incident, other	12
# Incidents for ST1 - Station 1: 231	

Riverside Volunteer Fire Department (IA)

Riverside, IA



This report was generated on 2/3/2021 11:20:06 AM

Incident Count for Zone for Date Range

Zone: All Zones | Start Date: 01/01/2020 | End Date: 12/31/2020

ZONE	NUMBER OF CALLS
Ainsworth - Ainsworth	3
City Limits - City Limits	74
Highland Township - Highland TWP	14
Hills - Hills	4
HWY 218 - Highway 218	13
Iowa City - Iowa City	1
Iowa Township - Iowa TWP	60
Jackson Township - Jackson TWP	4
Johnson CO. - Johnson CO.	1
Kalona - Kalona	12
Lone Tree - Lone Tree	2
Riverside Casino - Casino	43
TOTAL:	231

Incidents by Hour for Date Range

Start Date: 01/01/2020 | End Date: 12/31/2020

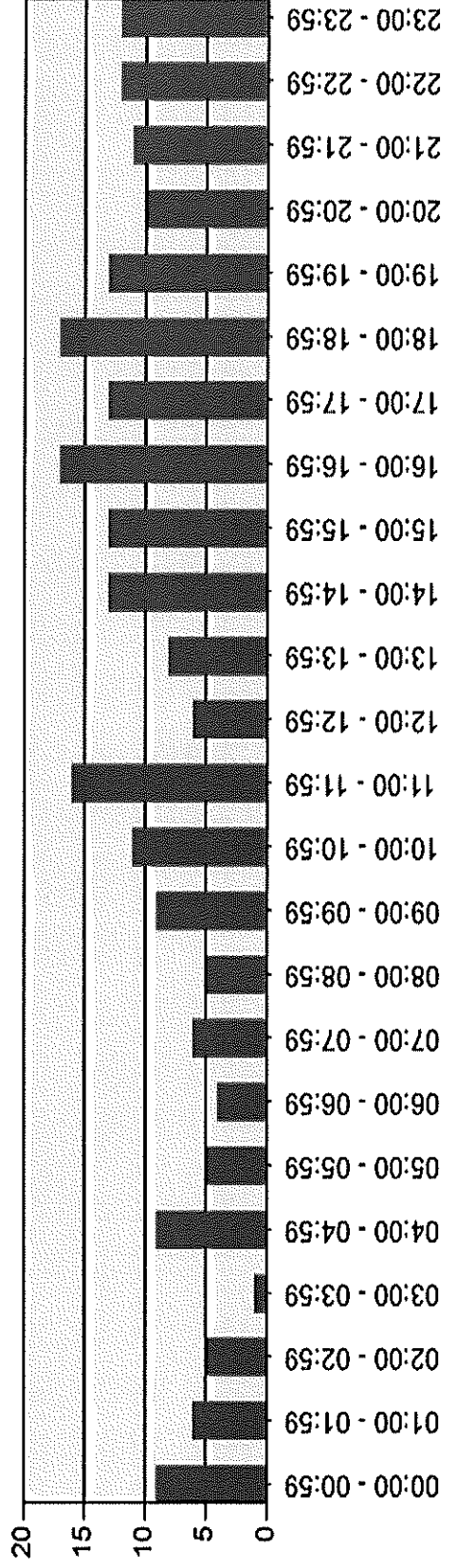

RFD 2020 PROJECTS & EVENTS

Santa visit in park

Fire Prevention Week tours &
visits

Drive Thru Pork Meal

Worked Thru COVID

NEW EMS/Rescue Truck

FIREFIGHTER CANCER RISK FIREFIGHTER'S HAVE A 10% GREATER RISK OF GETTING CANCER THEN GENERAL PUBLIC AND 15% HIGHER RISK OF DYING FROM CANCER

Immediate Actions You Can Take To Reduce Your Cancer Risk!

1. Use SCBA from initial attack to finish of overhaul.
2. Do gross field decon of PPE to remove as much soot and particulates as possible.
3. Use Wet-Nap or baby wipes to remove as much soot as possible from head, neck, jaw, throat, underarms and hands immediately and while still on the scene.
4. Change your clothes and wash them immediately after a fire.
5. Shower thoroughly after a fire.
6. Clean your PPE, gloves, hood and helmet immediately after a fire.
7. Do not take contaminated clothes or PPE home or store in your vehicle.
8. Decon fire apparatus interior after fires.
9. Keep bunker gear out of living and sleeping quarters.
10. Stop using tobacco products.
11. Use sunscreen or sun block.

The importance of annual medical examinations cannot be overstated early detection and treatment are essential to increasing survival.

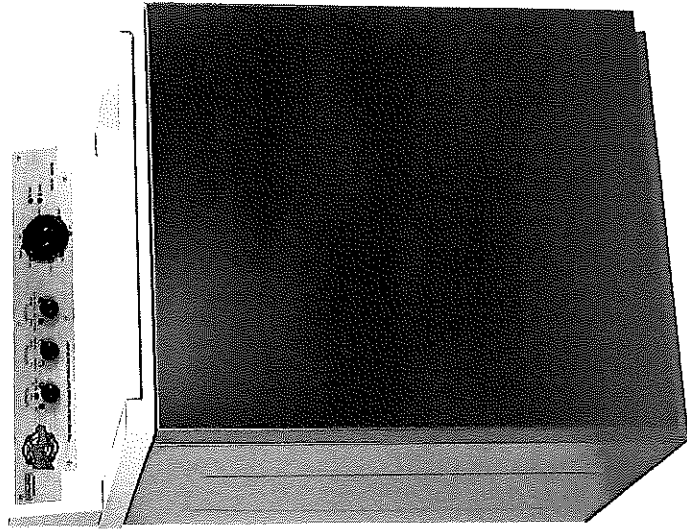
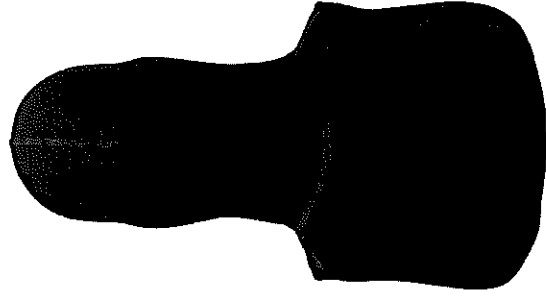

RFD TRAINING IN 2020

- Training Areas Covered
 - Fire, EMS, Rescue, Hazmat
- Hours Offered
 - Total – 59 (state min 24 hrs)
- RFD minimum 32 hours
- Total Training Hours For All Members - 600



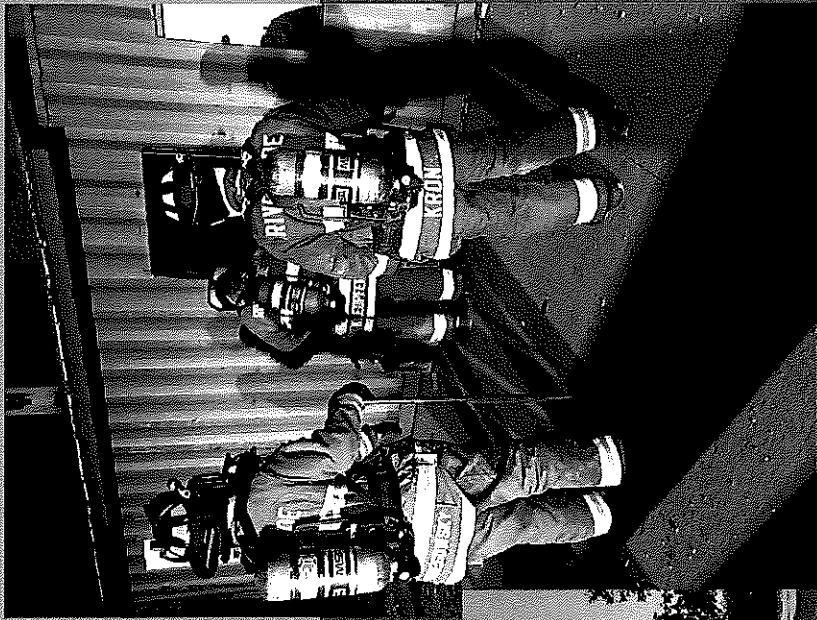

HOURS PUT IN BY MEMBERS 2020

- Calls 231 - Avg. 1 hr. per call minimum, Avg. 5 members per call
- Training - 32 Fire, 12 EMS Total - Total logged by all members 600hrs
- Meetings - Department Monthly 40hrs
- County Fire Meetings - 36hrs
- Special Events - 24hrs
- Truck Checks & Maintenance 40hrs
- Total Hours - 971 per member
- 32 Members Fire & EMS Volunteered over 31,072hrs. If paid for just these hours it would total over \$621,440. We're on call 24hrs a day 365 days a year.

RFD COMMAND STAFF

- RFD Officers
 - Fire Chief – Chad Smothers
 - Asst. Chief – Curtis Sexton
 - Deputy Chief – Toby Hancock
 - Captains – Chad Sexton, Jesse Kleopfer, Riley Kleopfer, Tony Simon
 - EMS Coordinator – Toby Hancock

• Total Members 2020 – 38

• 2021 – 31 (RFD had 8 members retire in 2020)



EMS

- Look at ways to provide better EMS medical coverage (Washington County Ambulance average response time to Riverside district 23.20 min) Continue to look at an RFD Transport Ambulance
- New County run ambulance service is in progress
- State of Iowa looking at taxation for EMS coverage
- RFD EMS certified members - 7
 - EMR -- 1
 - EMT -- 5
 - Paramedic -- 1

TRAINING FOR 2021

Building Pre Plans and Fire Alarm/Suppression
Systems

High Rise/Mid Rise fire attack operations

Grain Bin Rescue

Fire Ground Operations (Mutual Aid
Companies)

Agriculture Rescue

Regional Fire Schools and Conferences

EMS Skill, Trauma, Cardiac, Stroke

2021 PROJECTS

- Work on business pre plans/inspections
- Building updates (updates to office, overhead door safety, flooring, museum addition)
- Look at ways for recruitment & retention
- Apparatus replacement schedule and funding

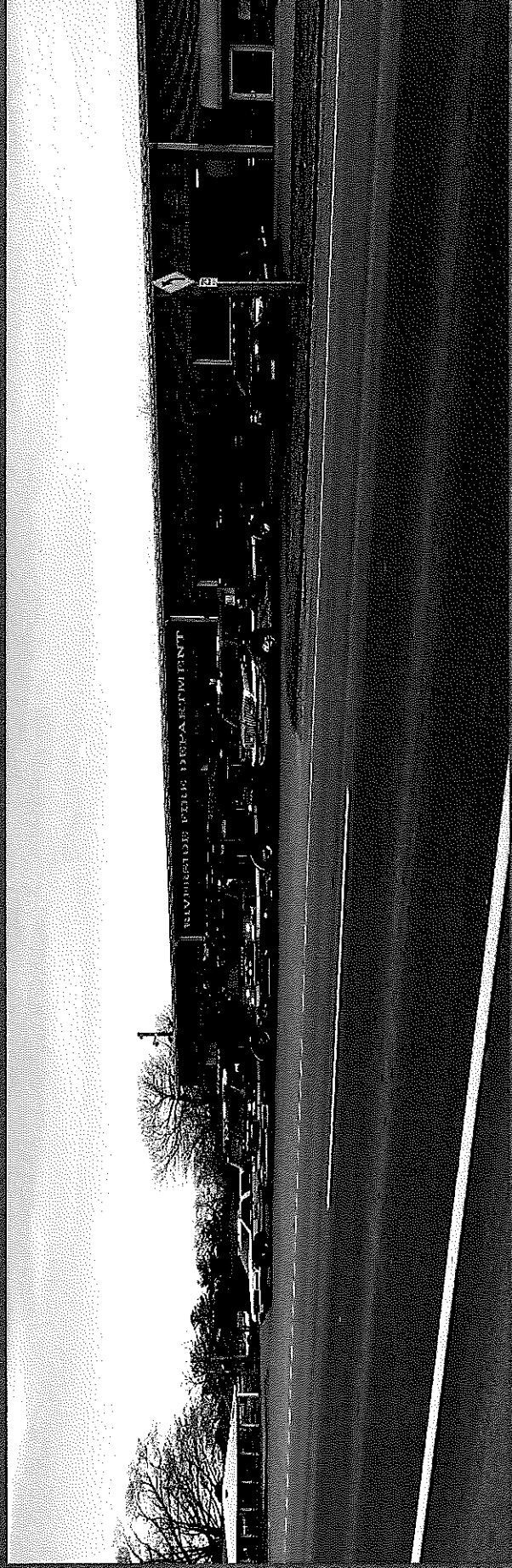

RADIOS/ COMMUNICATIONS

- Washington County emergency radio system, 800 mhz system
- New system 95% coverage, current system 39% coverage
- Riverside Radio Tower
- All new radios and pagers for departments – Purchased Jan. 2020
- Timeframe

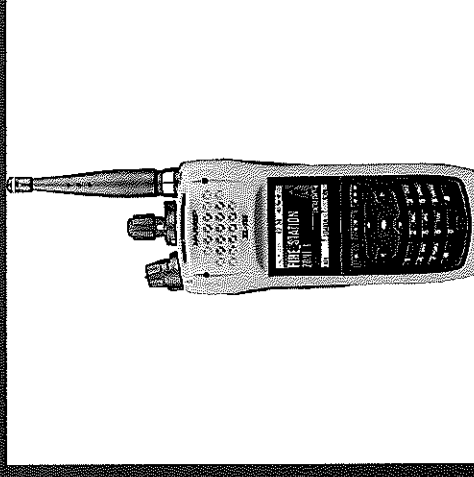
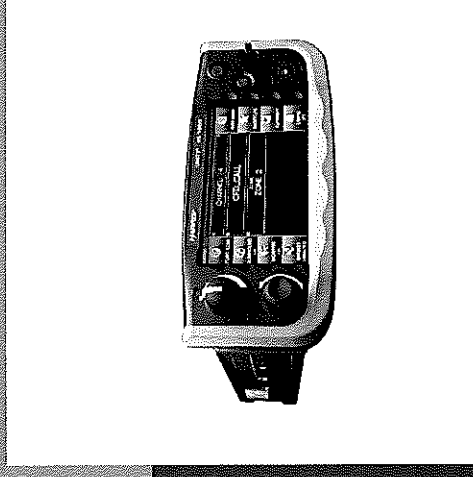

GO LIVE ON SYSTEM FEBRUARY 2021

APPARATUS REPLACEMENT

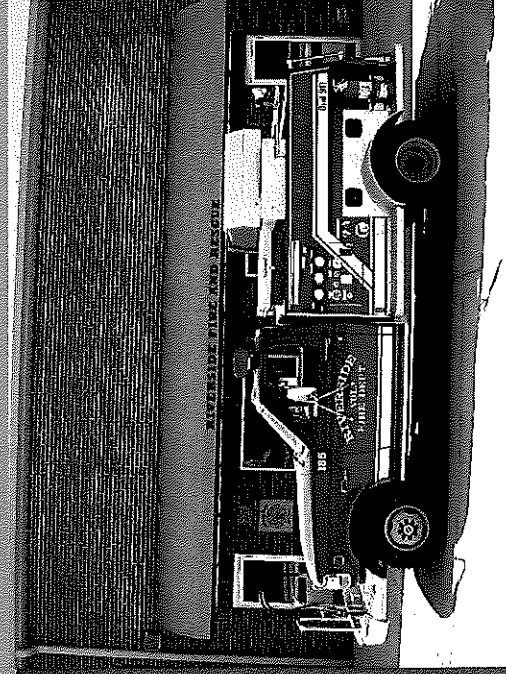

Brush 165 needs replaced, truck is a 1994, pump 1967

RFD APPARATUS CONDITION (REPLACEMENT COST)

- 161 – 2007 Pierce Engine, Good (\$350,000)
- 162 – 2016 Pierce Ladder, Excellent (\$775,000)
- 164 – 2018 Dodge Grass Truck, Excellent (\$30,000)
- 165 – 1994 Ford Grass Truck, Fair (\$30,000)
- 166 – 2008 Pierce Tanker, Excellent (\$225,000)
- 169 – 2021 Chevy Pickup, Excellent (\$70,000)
- Ranger – 2010 Polaris Ranger, Good (\$20,000)

RESA FUNDED PROJECTS 2020

- Fire Training for all members \$4,000
- Station Supplies (cleaning, water, gatorade, pop)
- Fitness equipment \$2500
- Meals and lodging for training
- Food for meetings and trainings
- Fire Prevention supplies
- RESA raised \$12,000 from fundraisers

2021 RESA FUNDED PROJECTS

- Update Fitness Equipment – \$2,500
- Training – \$5,000
- Burn Building Addition - \$5,000



THANK YOU FOR YOUR SUPPORT

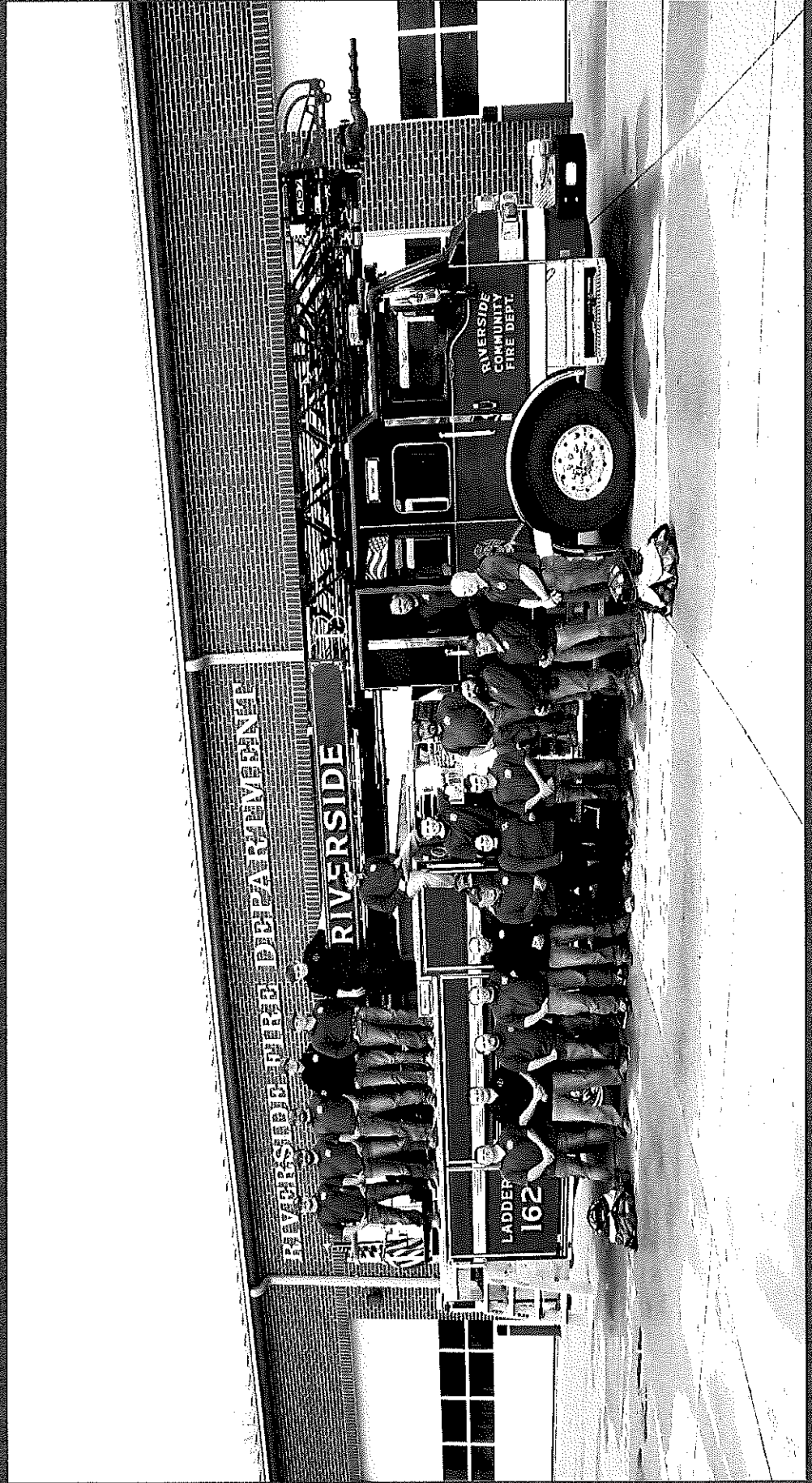



Request for funding:

Engine 161:

The attached work orders are for updates to Engine 161 on scene lighting and front bumper for better storage of equipment. This vehicle is our primary fire engine and was built in 2007. This vehicle we be in service at RFD for another 6-10 years and is due for some upgrades to make it meet our needs and improve lighting for scene safety. The funds for this project would come from our equipment account.

Brush 165:

This vehicle is on a 1994 chassis and the pump was built in 1967. The pump manufacture hasn't been in business for years. This vehicle currently has our member riding out from on the hood to fight fires which is not the safest thing. This vehicle has leaks and is becoming worn out. We would like to replace this brush truck with a more modern apparatus that meets our needs for brush fires and emergency response in general. The cost of a new brush truck would be around \$85,000 to \$100,000. We would like to use funds from the \$300,000 that's currently in our FY budget that was for replacing 168. We replace 168 and 160 with 1 vehicle and spent around \$50,000 out of the \$300,000. This would be the last truck we need to look at replacing until Engine 161 comes due in 6-10 years.

Riverside Volunteer Fire Department (IA)

Riverside, IA

This report was generated on 1/1/2021 8:38:07 AM



Incident Type Count per Station for Date Range

Start Date: 01/01/2020 | End Date: 12/31/2020

INCIDENT TYPE	# INCIDENTS
Station: ST1 - STATION 1	
111 - Building fire	23
141 - Forest, woods or wildland fire	1
142 - Brush or brush-and-grass mixture fire	4
221 - Overpressure rupture of air or gas pipe/pipeline	1
311 - Medical assist, assist EMS crew	36
321 - EMS call, excluding vehicle accident with injury	105
322 - Motor vehicle accident with injuries	12
324 - Motor vehicle accident with no injuries.	6
341 - Search for person on land	1
411 - Gasoline or other flammable liquid spill	1
412 - Gas leak (natural gas or LPG)	1
445 - Arcing, shorted electrical equipment	1
552 - Police matter	1
553 - Public service	1
554 - Assist invalid	3
600 - Good Intent call, other	7
611 - Dispatched & cancelled en route	11
700 - False alarm or false call, other	1
731 - Sprinkler activation due to malfunction	1
733 - Smoke detector activation due to malfunction	1
736 - CO detector activation due to malfunction	1
900 - Special type of incident, other	12 - in Sire district
# Incidents for ST1 - Station 1:	231

4 a.m. - 7 a.m.

Only REVIEWED incidents included.



Riverside Volunteer Fire Department (IA)



Riverside, IA

This report was generated on 1/1/2021 8:41:05 AM

Incident Count for Zone for Date Range

Zone: All Zones | Start Date: 01/01/2020 | End Date: 12/31/2020

ZONE	NUMBER OF CALLS
Ainsworth - Ainsworth	3
City Limits - City Limits	74
Highland Township - Highland TWP	14
Hills - Hills	4
HWY 218 - Highway 218	13
Iowa City - Iowa City	1
Iowa Township - Iowa TWP	60
Jackson Township - Jackson TWP	4
Johnson CO. - Johnson CO.	1
Kalona - Kalona	12
Lone Tree - Lone Tree	2
Riverside Casino - Casino	43
TOTAL:	231

Zone information is defined on the Basic Info 3 screen of an incident. This report counts each exposure. Only REVIEWED incidents included.



Riverside Volunteer Fire Department (IA)

Riverside, IA

This report was generated on 1/15/2021 9:49:35 AM



Incidents by Month for Month Range

Start Month: January | End Month: December | Year: 2020

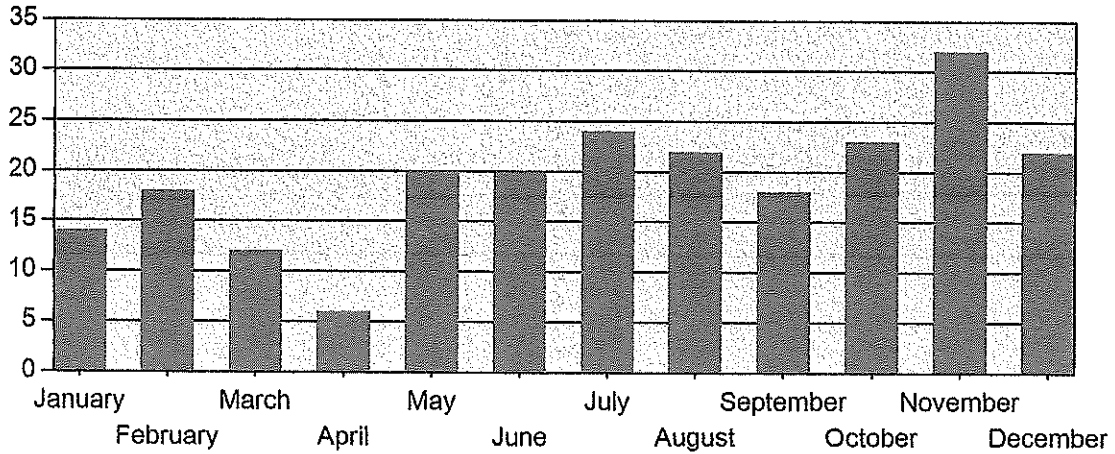

MONTH	INCIDENTS
January	14
February	18
March	12
April	6
May	20
June	20
July	24
August	22
September	18
October	23
November	32
December	22

Only REVIEWED incidents included



emergencyreporting.com

Doc Id: 10

Page # 1 of 1

Riverside Volunteer Fire Department (IA)



Riverside, IA

This report was generated on 1/15/2021 9:54:25 AM

Incidents by Hour for Date Range

Start Date: 01/01/2020 | End Date: 12/31/2020

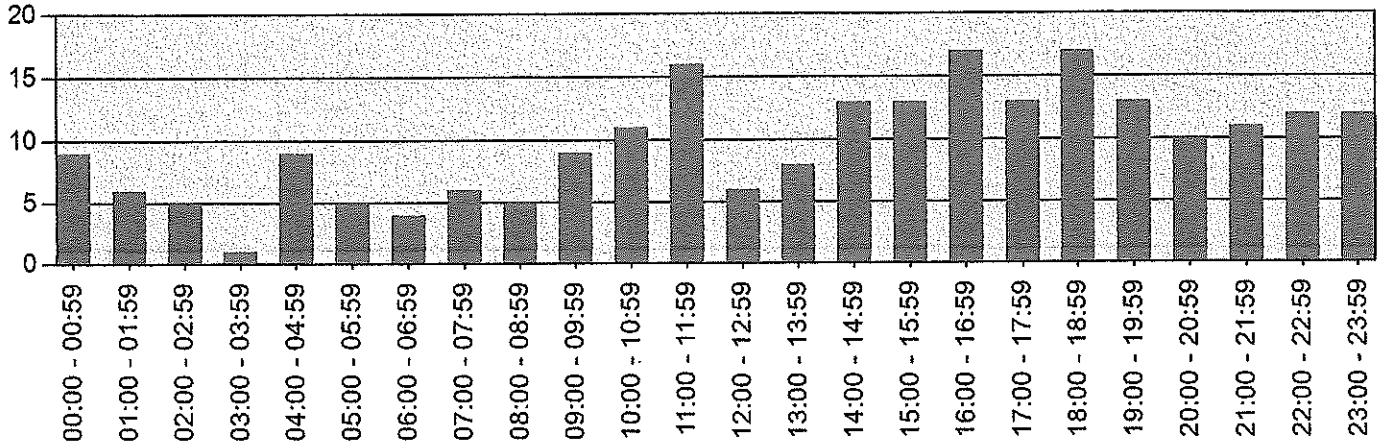

HOUR	# of CALLS
00:00 - 00:59	9
01:00 - 01:59	6
02:00 - 02:59	5
03:00 - 03:59	1
04:00 - 04:59	9
05:00 - 05:59	5
06:00 - 06:59	4
07:00 - 07:59	6
08:00 - 08:59	5
09:00 - 09:59	9
10:00 - 10:59	11
11:00 - 11:59	16
12:00 - 12:59	6
13:00 - 13:59	8
14:00 - 14:59	13
15:00 - 15:59	13
16:00 - 16:59	17
17:00 - 17:59	13
18:00 - 18:59	17
19:00 - 19:59	13
20:00 - 20:59	10
21:00 - 21:59	11
22:00 - 22:59	12
23:00 - 23:59	12

Only REVIEWED incidents Included



emergencyreporting.com

Doc Id: 19

Page # 1 of 1

Riverside Volunteer Fire Department (IA)

Riverside, IA

This report was generated on 1/15/2021 10:01:07 AM



Incident Count by Weekday and Hour for Zone for Shift for Date Range

Personnel: All Personnel | Shift(s): All Shifts | Zone: All Zones | Start Date: 01/01/2020 | End Date: 12/31/2020

Hour	Sun	Mon	Tue	Wed	Thu	Fri	Sat	Hour	Total per Hour	Percent
00:00	3	0	0	2	2	0	1	00:00	8	3.48%
01:00	2	0	2	0	1	1	0	01:00	6	2.61%
02:00	1	0	0	0	1	1	2	02:00	5	2.17%
03:00	0	0	0	1	0	0	0	03:00	1	0.43%
04:00	2	4	1	1	1	0	0	04:00	9	3.91%
05:00	2	1	0	1	1	0	0	05:00	5	2.17%
06:00	0	2	0	0	0	1	1	06:00	4	1.74%
07:00	1	0	0	0	1	2	2	07:00	6	2.61%
08:00	0	1	0	2	1	0	1	08:00	5	2.17%
09:00	1	1	1	3	0	3	0	09:00	9	3.91%
10:00	1	1	1	1	1	2	4	10:00	11	4.78%
11:00	5	1	3	1	2	1	3	11:00	16	6.96%
12:00	1	1	1	0	0	2	1	12:00	6	2.61%
13:00	2	1	0	1	2	2	0	13:00	8	3.48%
14:00	3	0	1	3	3	1	2	14:00	13	5.65%
15:00	1	3	1	2	2	3	1	15:00	13	5.65%
16:00	3	3	2	4	1	2	2	16:00	17	7.39%
17:00	3	1	1	2	2	1	3	17:00	13	5.65%
18:00	1	2	1	3	4	2	4	18:00	17	7.39%
19:00	1	1	1	3	0	5	2	19:00	13	5.65%
20:00	0	1	3	1	0	2	3	20:00	10	4.35%
21:00	1	4	0	0	1	4	1	21:00	11	4.78%
22:00	3	0	1	1	0	3	4	22:00	12	5.22%
23:00	1	0	1	2	1	4	3	23:00	12	5.22%
Total Responses for Day	38	28	21	34	27	42	40	Total	230	100.00%
% of Responses for Day	13.16%	14.29%	14.29%	11.76%	14.81%	11.90%	10.00%			
% of Responses for Week	16.52%	12.17%	9.13%	14.78%	11.74%	18.26%	17.39%			

Incident Count by Weekday and Hour for Zone, for Shift and Date Range. Zone information is defined on the Basic Info 3 screen of an incident. Only REVIEWED incidents included. Maximum call volumes for each day are shown with a RED background, and maximum call volumes for each hour are shown with a BLUE background. "% of Responses for Day" indicates the maximum hourly call volume as percentage of total calls for the day of the week. "% of Responses for Week" indicates the total number of calls for the day of the week as a percentage of total calls.



Expenses from Fund 300 (originally ambulance vehicle

Budget	\$	300,000.00	
Revenue Offset	\$	(120,000.00)	
Buyout of contract	\$	(5,000.00)	council approved
New vehicle purchase	\$	(34,880.00)	council approved
Lights for new vehicle	\$	<u>11,373.02</u>	council approved from maint budget- could be transferred
Balance	\$	151,493.02	
Lights 161	\$	(7,015.00)	if council approves)
Bumper 161	\$	<u>(11,445.48)</u>	if council approves)
Vehicle budget balance	\$	133,032.54	

Estimate



Emergency Apparatus Maintenance, Inc.
7512 4th Avenue
Lino Lakes, MN 55014

Date: 01/21/2021

Estimate #: 8911

TEL: 651.786.4463 • 1.800.EAM.3911
FAX: 651.786.0517
EML: service@eamservice.com

Chad Smothers
Riverside, IA Fire Department
271 1st Street West
Riverside, IA 52327

Sales Rep: Donald Duncan

Signature: _____

Description

Engine

Quantity	Description	Unit Cost	Cost
1	EAM proposes to remove 3 old scene lights and replace with 3 new LED scene lights Price includes parts and labor Price does not include shipping	\$7,015.00	\$7,015.00

Description

Quantity	Description	Unit Cost	Cost
1	Travel Charge: Please note this estimate does not include travel charges. Travel is split between all departments on the service run and will be added to final invoices.		

Summary

This estimate is based on the average parts and labor required to complete the stated repairs. These estimates are figured upon average accessibility to parts requiring repairs and will be charged on a time and materials basis.

*Thank you for the opportunity to provide an estimate for this project. If you have any questions regarding this estimate, or if we can be of further assistance, please call us at **651.786.4463** or **1.800.326.3911**, or email us at service@eamservice.com.*



Reliant Fire Apparatus
 880 Enterprise Drive
 PO BOX 470
 Slinger, WI 53086
 Tel: 262-297-5020
 Fax: 262-297-5022

ORDER REQUEST
ESTIMATE

Estimate For:

RIVERSIDE FIRE DEPARTMENT
 PO BOX 111

 RIVERSIDE IA 52327

Ship To: Riverside Fire and Rescue
 60 North Green St
 Riverside IA 52327

Date	A/C No.	Currency	Payment Term	Page No.
Sep 23, 2020	RIVERSIDE	USD	NET 30	1 / 1

Request 3OR000113

Reference Quoted

Parts No.	Parts Description	Qty	Charge	Total
CB-FAB1-3303	Riverside Bumper	1.00	10,105.12	10,105.12
	Add \$600 to line-x the bumper lid			
40-8160	MNTG BRKT,AIR HORN,FRONT	2.00	7.48	14.96
1159616	HORN,AIR,25,CHROME,GROVER,	2.00	551.51	1,103.02
2887284	BRKT,AIR HORN,RR	2.00	111.19	222.38

Estimate Total:	11,445.48
------------------------	------------------

Crate fee of \$300.
 Shipping charges not included.
 Estimate is valid for 30 days.

A surcharge of 4.00% of the transaction amount on Visa and Mastercard purchases, which is not greater than our cost of acceptance, will be charged. We do not surcharge Visa and Mastercard debit cards.

ZONE	REV	DESCRIPTION	DATE	PREP	APP'D

2	REVISION HISTORY

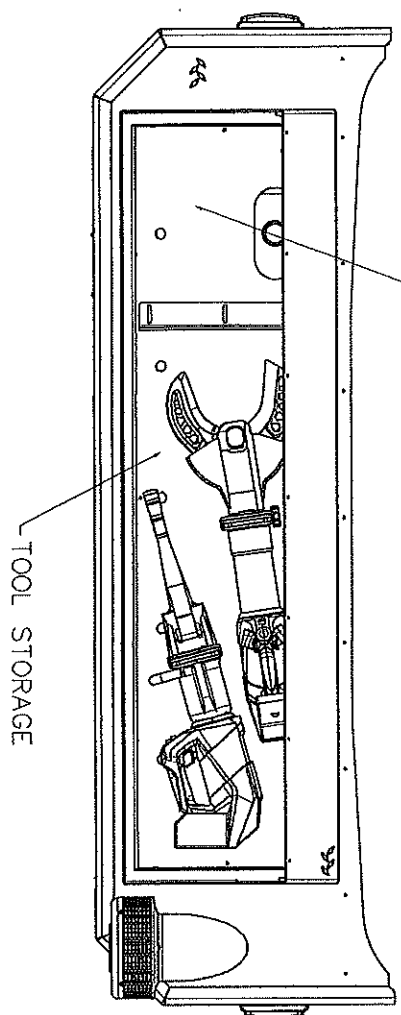
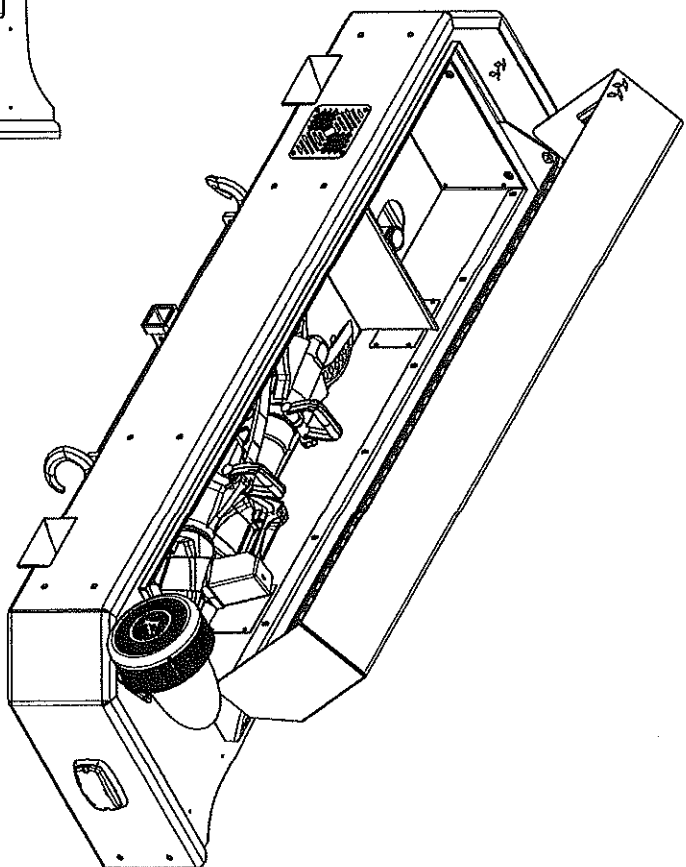

- NOTES:
1. DIMENSIONS OR NOTES CONTAINED WITHIN PARENTHESES ARE FOR REFERENCE ONLY.
 2. SEE ASME Y14.100 FOR DRAWING INTERPRETATION STANDARDS.

COMMERCIAL (EAR99)
 THIS DRAWING IS SUBJECT TO THE EXPORT ADMINISTRATION REGULATIONS. YOU MAY NOT PROVIDE IT TO ANY PROHIBITED END-USERS OR FOR ANY PROHIBITED END-USERS AS SET FORTH IN U.S. EXPORT CONTROLS.

THIS DRAWING IS PROVIDED ON A CONFIDENTIAL BASIS SUBJECT TO RETURN OR DESTRUCTION BY PIERCE MANUFACTURING INC. (PIERCE) IN WRITING AND MAY BE REPRODUCED OR TRANSMITTED IN ANY FORM OR BY ANY MEANS, ELECTRONIC OR MECHANICAL, INCLUDING PHOTOCOPYING, RECORDING, OR BY ANY INFORMATION STORAGE AND RETRIEVAL SYSTEM, WITHOUT THE PRIOR WRITTEN AUTHORIZATION OF PIERCE. PIERCE MANUFACTURING INC., CAMPBELL, OHIO 43081

REVISION	DATE	DESCRIPTION	BY	CHKD	APP'D
1					

DATE	11/11/2011	TIME	10:00 AM
BY	D. SZ	CHKD	TBU
APP'D			
DATE		TIME	
BY		CHKD	
APP'D			

PIERCE MANUFACTURING
 APPLETON, WI 54912 USA
DRAWING TEMPLATE
 D. SZ TBU
 01 OF 01

Christine Yancey

From: Chad Smothers <chadsmothers.cs@gmail.com>
Sent: Thursday, March 11, 2021 11:52 AM
To: Allen Schneider; Christine Yancey
Subject: RFD

The 2 projects I submitted for Engine 161 are specific to our fire truck. The truck is built by Pierce Manufacturing who builds our fire trucks. The bumper comes engineered from Pierce for that truck specifically, there's no other place to get that. We can't put another manufacturer's parts on our trucks, example of buying Ford parts or equipment for a Toyota. The scene lights are a spec for this fire engine also and installed by the company who does our fire truck service, repair and warranty work through our Pierce representative Reliant Fire Apparatus. I am not able to get other quotes as this stuff is specific to this vehicle. It's not like getting companies to bid on door locks or cleaning supplies or non specific equipment to our job. If you have questions let me know and I hope these items can be on the agenda.

Thanks
Chief Smothers

NOTICE: This email originated from outside the organization. Do not click links or open attachments unless you recognize the sender and know the content is safe.



Date: March 10, 2021

To: Riverside Council

From: Bill Stukey, Operator

O & M Report: February 2021

Water Operation & Maintenance

- On February 5th we experienced a power outage at the water plant for about an hour. The generator started and was powering the plant, but we had some electronic failures in the high service pump room. There is one electric heater to heat the building and pipes. The heater failed and would not start. I had Precision Electric look at the heater that day to get heat in the building that day before the subzero temperatures set in over the weekend. Precision Electric said they would have to repair the heater and would not be until the following week that it would be fixed. I had them swap it for a working one in the plant and was able to keep heat in the high service room.
- The power outage also took out our level controller for the clear well. This controller tells the PLC how much water in the clear well so the plant knows when to start and stop. I called the manufacturer and they would not be able to get the unit repaired for a few weeks. I found a supplier that shipped us a new unit and would have it the following Monday. On that Monday Electric Pump installed the new unit and had the plant back in auto operation again. Over the weekend I manually turned the plant on and off to keep the clear well full.
- During the subzero temperatures we had one day where the water line to the aerator partially froze and was restricting water flow, resulting in too much back pressure and not allowing the plant to run. I was able to start the plant on one skid for about thirty minutes and the water thawed the rest of the line. After a half hour I was able to run on two skids again and the plant was put back in normal operation.



Discover The Power Of People



www.peopleservice.com



- I had a call from a resident at Walnut Towers about rusty water. From previous experience I have found they conduct their annual sprinkler system testing in late February to early March. When they flush their lines it stirs up sediment in the building's lines and causes one or two residents to have rusty water. When I spoke to the resident about the issue, she stated they had been working on the sprinkler system that day. I advised the resident to flush their cold water tap until clear. No further action was taken.
- I located and shut off the water for Casey's east of the interstate. They were redoing plumbing and needed the water off for a short time.
- 7 door postings and 1 disconnect.
- 2 locates and 1 emergency locate, all complete.

Wastewater Operation & Maintenance

- The cold temperatures had caused some minor issues at the wastewater plant. Some of the sensors that indicate when valves are open or shut were not making good contact and would give a fault. There were no indications of an actual problem. I checked the faulted valves and they were functioning properly, but the indicators were sticking. The issue has since been resolved with warmer weather.
- I had received a call on February 23rd around 7 PM that the alarm light on LS3 was flashing. I came and looked at it and found pump one would not run and the VFD was faulted. I called Iowa Pump to look at it the next time they were in the area. They pulled the pump and found it had clogged. They removed the debris and placed the pump back in service.

Iowa Department of Natural Resources

➤



Discover The Power Of People



www.peopleservice.com

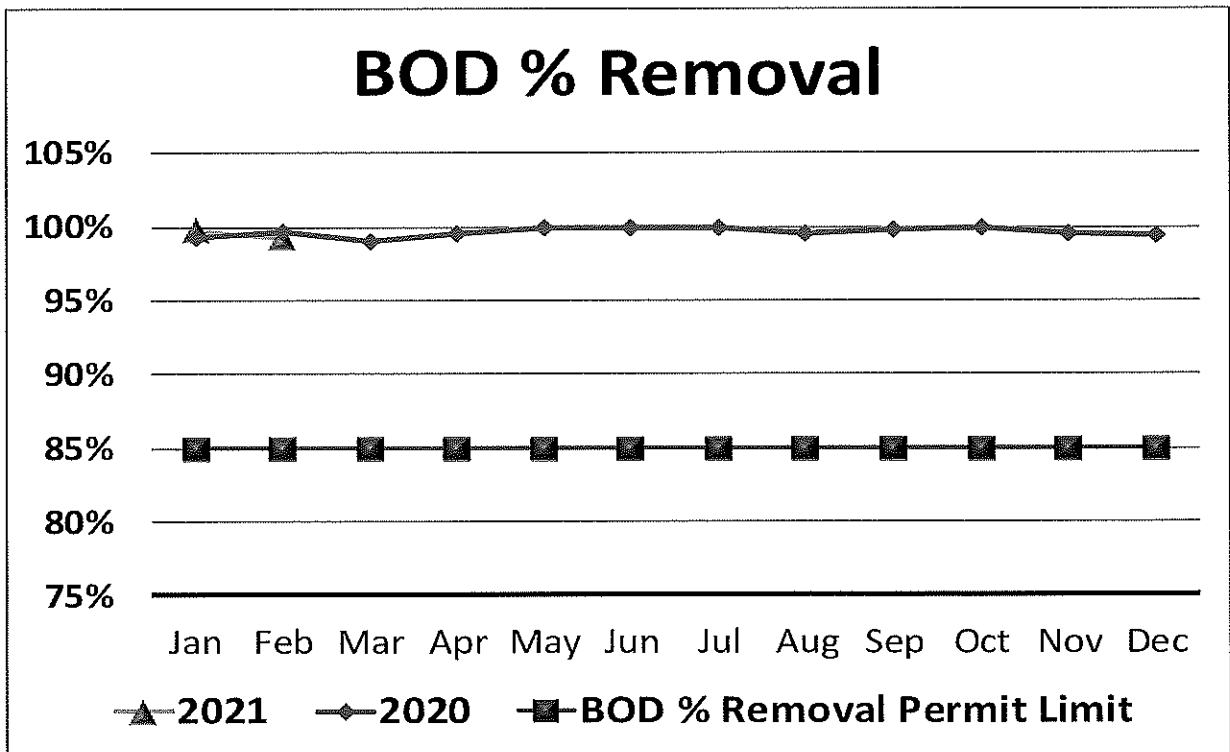
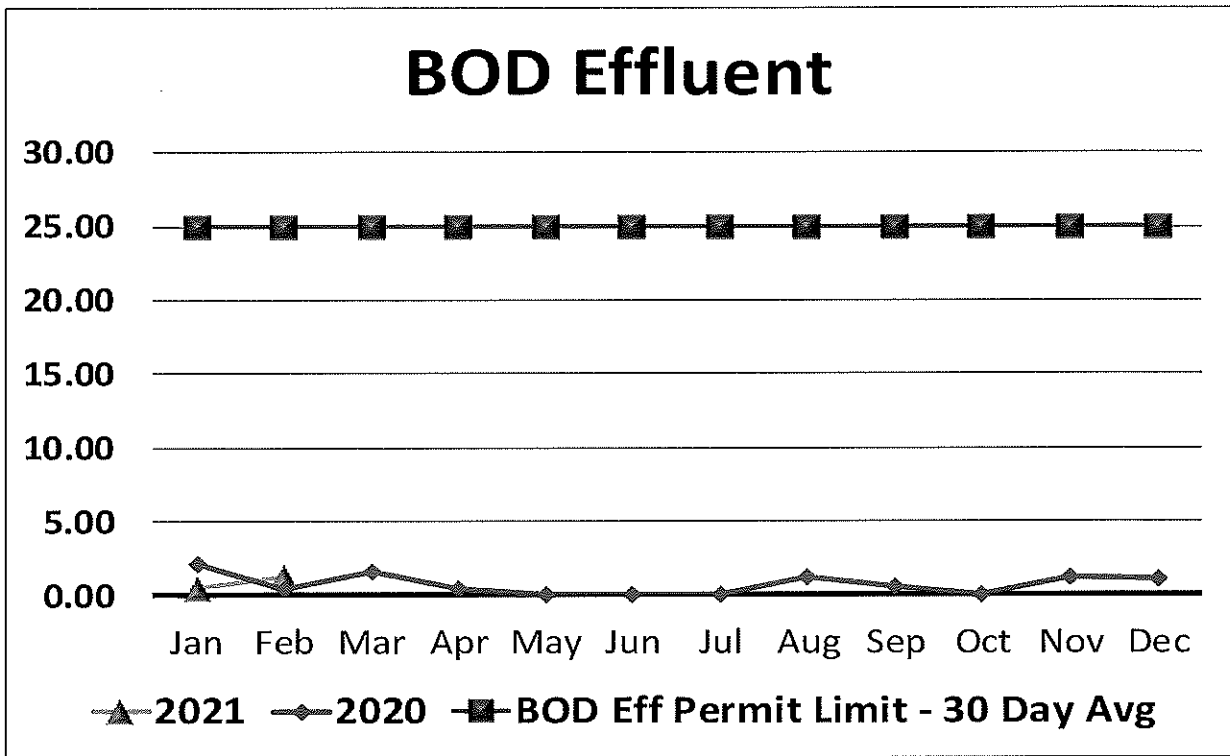

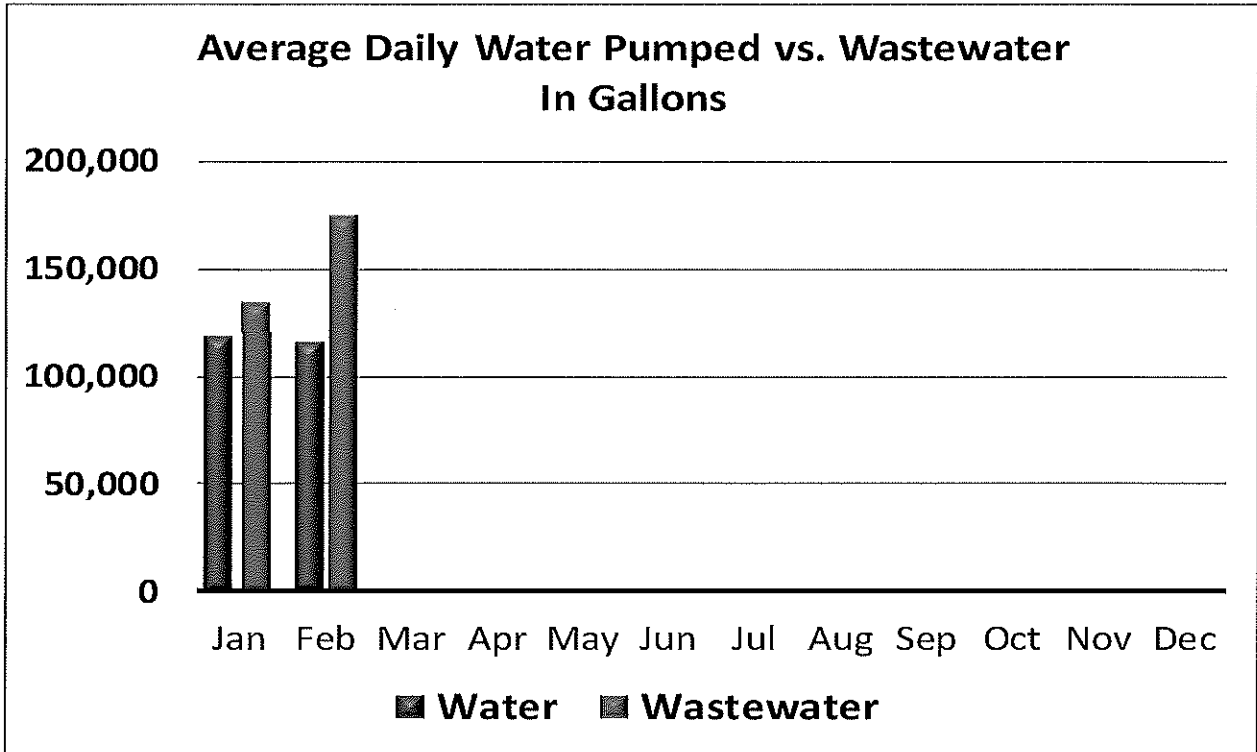

Contract True-Ups - Current Contract Year				
Item	Budgeted Amount	Amount Spent	% of Budget	% of Time
Chemical Budget	\$26,209.00	\$6,413.75	24%	67%
Maintenance Budget	\$21,840.00	\$8,756.15	40%	67%
Total	\$48,049.00	\$15,169.90	32%	67%

PeopleService INC.

Water & Wastewater Professionals

		February-21	January-21	February-20
Water				
	Units			
Total Monthly Pumped	gallons	3,243,000	3,696,000	3,423,000
Average Daily Pumped	gallons	115,820	119,230	118,030
Maximum Daily Pumped	gallons	188,000	210,000	186,000
Minimum Daily Pumped	gallons	61,000	37,000	80,000
Chlorine				
Chlorine - Total Avg Residual Plant	mg/L	1.53	1.01	1.53
Chlorine - Total Avg Residual System	mg/L	0.82	0.91	1.07
Chlorine - Recommended Residual System	mg/L	0.30	0.30	0.30
Chlorine used	lbs	108.00	140.50	102.00
Iron				
Iron - Avg Raw	mg/L	2.20	1.92	1.87
Polyphosphate				
Polyphosphate - Avg Residual	mg/L	1.21	1.22	1.23
Polyphosphate - Recommended Residual	mg/L	0.5 - 2.0	0.5 - 2.0	0.5 - 2.0
Polyphosphate used	lbs	20.50	27.50	11.00
Water Loss				
Water Billed	gallons	2,552,355	2,755,544	2,802,417
Water used in main breaks/hydrant flushing	gallons	0	0	50,000
Water used at city buildings	gallons	0	0	82,015
Loss	gallons	0%	0%	19%
Wastewater				
BOD				
BOD Influent Avg	mg/L	166	241	228
BOD Effluent Avg	mg/L	1	0.5	1
BOD Eff Permit Limit - 30 Day Avg	mg/L	25	25	25
BOD % Removal	%	99.24%	99.79%	99.70%
BOD % Removal Permit Limit	%	85%	85%	85%
TSS				
TSS Influent Avg	mg/L	99	196	126
TSS Effluent Avg	mg/L	4	1	1
TSS Effluent Permit Limit - 30 Day Avg	mg/L	30	30	30
TSS % Removal	%	95.90%	99.36%	99.00%
TSS % Removal Permit Limit	%	85%	85%	85%
Nitrogen Ammonia				
NA Effluent Avg	mg/L	2	3	1
NA Effluent Permit Limit - 30 Day Avg	mg/L	17	14	17
Influent Flow				
Total Monthly	gallons	4,894,500	4,182,000	4,726,000
Average Daily	gallons	174,803	134,903	162,965
Maximum Daily	gallons	466,800	223,200	311,800
Minimum Daily	gallons	103,500	97,800	61,300
Permit Limit - 30 Day Avg	gallons	444,000	444,000	444,000
Permit Limit - Daily Maximum	gallons	1,425,000	1,425,000	1,425,000

PeopleService INC.
 Water & Wastewater Professionals
RIVERSIDE--FEBRUARY '21

Water Plant Maintenance

<u>Date</u>	<u>Vendor List</u>	<u>Description</u>	<u>Total</u>
2/17/21	Rhino Industries	Filters	\$1,320.00
2/22/21	First National Bank, VISA	Supplies	\$45.51
		Total	\$1,365.51

Water System Maintenance

<u>Date</u>	<u>Vendor List</u>	<u>Description</u>	<u>Total</u>
2/22/21	First National Bank, VISA	Supplies	\$6.96
		Total	\$6.96

Wastewater Plant Maintenance

<u>Date</u>	<u>Vendor List</u>	<u>Description</u>	<u>Total</u>
2/22/21	First National Bank, VISA	Supplies	\$45.50
		Total	\$45.50

Wastewater System Maintenance

<u>Date</u>	<u>Vendor List</u>	<u>Description</u>	<u>Total</u>
2/22/21	First National Bank, VISA	Supplies	\$6.97
		Total	\$6.97

Water Plant Maintenance	\$1,365.51
Water System Maintenance	\$6.96
WW Plant Maintenance	\$45.50
WW System Maintenance	\$6.97
Month Total	\$1,424.94

Annual Maintenance Budget \$21,840.00

Total Maintenance Dollars Spent Year to Date \$8,756.25

Percent Maintenance Budget Spent Year to Date 40%



RIVERSIDE - FEBRUARY '21

Water System Chemicals

<u>Date</u>	<u>Vendor List</u>	<u>Description</u>	<u>Total</u>
2/9/21	Hawkins	Sodium Hypochlorite	\$252.00
2/9/21	Hawkins	Caustic	\$177.75
		Total	\$429.75

Wastewater System Chemicals

<u>Date</u>	<u>Vendor List</u>	<u>Description</u>	<u>Total</u>
		Total	\$0.00

Water System Chemicals	\$429.75
W/W System Chemicals	\$0.00
Month Total	\$429.75

Annual Chemical Budget \$26,209.00

Total Chemical Dollars Spent Year to Date \$6,413.75

Percent Chemical Budget Spent Year to Date 24%

Maintenance Month Total	\$1,424.84
Chemical Month Total	\$429.75
Month Total	\$1,854.59

Annual Budget \$48,049.00

Total Spent Year to Date \$15,169.90

Percent Budget Spent Year to Date 32%





Work Orders Completed

Date completed	Equipment	Task
2/8/2021	BLOWERS	Monthly PM
2/3/2021	WWTP GENERATOR	Monthly PM
2/22/2021	LIFT STATION #1	LS Monthly PM
2/22/2021	LIFT STATION #2	LS Monthly PM
2/22/2021	LIFT STATION #3	LS Monthly PM
2/22/2021	LIFT STATION #4	LS Monthly PM
2/22/2021	LIFT STATION #5	LS Monthly PM
2/15/2021	MAIN LIFT STATION	LS Monthly PM
2/3/2021	EFFLUENT SAMPLER	Monthly PM
2/3/2021	INFLUENT SAMPLER	Monthly PM
2/15/2021	SCREEN UNIT	Monthly PM
2/8/2021	UV SYSTEM	Monthly PM
2/2/2021	FIRE EXTINGUISHERS	Inspection
2/3/2021	FILTER	Monthly PM
2/2/2021	CARTRIDGE FILTERS	Monthly PM
2/2/2021	DEHUMIDIFIERS	Monthly PM
2/2/2021	WATER PLANT GENERATOR	Monthly PM
2/2/2021	HIGH SERVICE PUMPS	Monthly PM
2/1/2021	HIGH SERVICE PUMP #1	Service Equipment
2/1/2021	HIGH SERVICE PUMP #2	Service Equipment
2/1/2021	HIGH SERVICE PUMP #3	Service Equipment
2/1/2021	HIGH SERVICE PUMP #4	Service Equipment
2/2/2021	FIRE EXTINGUISHERS	Inspection



**NOTICE OF PUBLIC HEARING
FOR THE CITY COUNCIL
OF THE CITY OF RIVERSIDE, IOWA**

The City Council of the City of Riverside, Iowa will hold a public hearing for the purpose of selling parcel 04-18-237-004, 40 E 2nd Street in the amount of \$124,000.00. The Public Hearing will be held during the City Council meeting on Monday, March 15th, 2021 which begins at 6:00 p.m., at City of Riverside Fire Station.

All interested persons are invited to attend the public hearing and to offer comments, orally or in writing, in support of, or in opposition of the sale. Written comments may be submitted to the Riverside City Clerk, P.O. Box 188, Riverside, IA 52327-0188, in advance of the public hearing. Any questions regarding the sale of property may also be directed to City Hall.

This notice is published at the direction of the City Council for the
City of Riverside, Iowa.

Becky LaRoche

City Clerk

*E-mail
to
NEWS
3-2-21
4pm
RL*

RESOLUTION #031521-01

RESOLUTION TO SELL CITY PROPERTY AT 40 E. 2ND STREET TO PINNACLE 6 PROPERTIES

WHEREAS, the City of Riverside, Iowa, held a public hearing on the Sale of City Property at 40 E. 2nd Street to Pinnacle 6 Properties of West Liberty on March 15th in the City Fire Station located at 271 E 1st Street, Riverside, Iowa. There were no written or oral objections to the sale.

THEREFORE, BE IT RESOLVED, The City of Riverside City Council, hereby approves the sale of property at 40 E. 2nd Street to Pinnacle 6 Properties in the amount of 124,000.

IT WAS MOVED BY Councilperson _____, seconded by Councilperson _____, to approve the foregoing resolution.

Roll Call: Sexton, Rodgers, Redlinger, McGuire, Schneider

Ayes:

Nays:

Abstain/Absent:

PASSED AND APPROVED by the City Council of Riverside, Iowa and approved this 15th day of March, 2021.

Signed: _____ Date: _____

Allen Schneider, Mayor

Attest : _____ Date: _____

Becky LaRoche, City Clerk

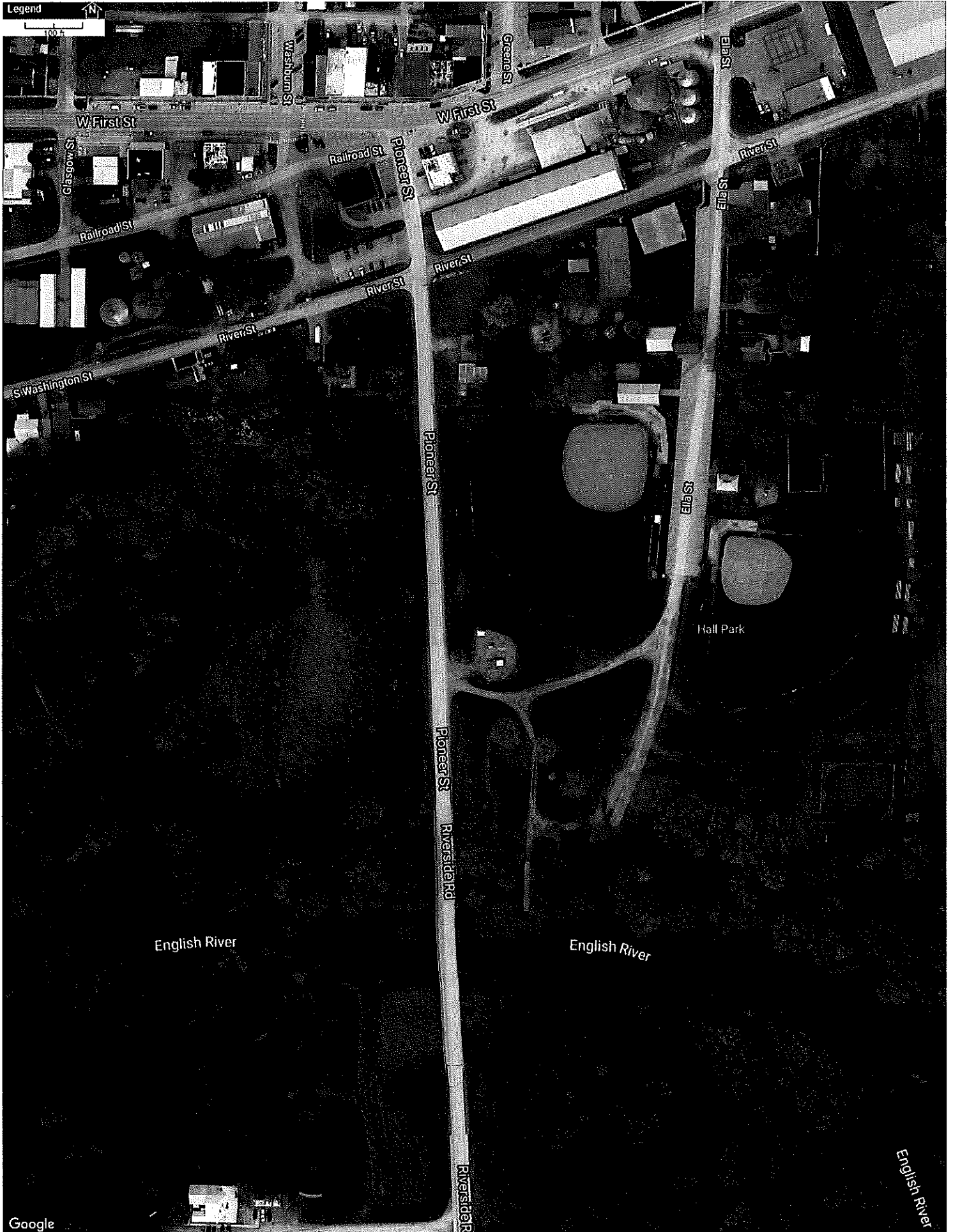



City of Riverside
Administrator Report
March 15, 2021

- Staff meetings on Monday at 8:30
- Payroll review
- Agenda prep
- Bi-weekly phone meeting with Mayor
- Phone meetings with KCI
- RFP/RFQ for engineering services
- Phone calls and emails with The News
- Password Policy
- Computer Policy
- Job Descriptions
- Audit
- Finishing up FEMA for Derecho
- WEDG dinner
- Ordinance changes
- Tours for Community Center Committee
- Possible county-wide Chamber of Commerce

Public Works:

- Cleaned up snow downtown
- Hauled snow to park
- Cleaned equipment, minor repairs
- Worked on speed sign battery
- Lowered and raised flags
- Cleaned out intakes
- Snow removal list
- Removed plows on trucks
- Serviced mowers
- Vehicle airbag alarm repair to dealer
- Cleaned front of City Hall
- Bids for Dog Park changes
- Snow plow cylinder repair
- Worked on concession stand door
- Removed Christmas trees from park
- Jay-permits
- Took in skid loader bucket to Big Iron for welding

2/28/2021

Treasurer's Report	\$ 3,211,558.27
Cash on Hand	
Peoples Checking	\$ 711,676.75
Peoples MM	\$ 1,126,549.53
Hills Bank	\$ 349,846.31 (Water/Sewer/Garbage, Storm Water)
Total	\$ 2,188,072.59

CD's and Savings	CD's	Savings
CC CD's	\$ 294,661.21	
CC CD's	\$ 226,665.43	
Water CD		
CC Savings		\$ 502,159.04
Total CD's & Savings	\$ 521,326.64	\$ 502,159.04

Cash On Hand	\$ 2,188,072.59	
	Cash	Reserves
General	\$ 339,092.74	\$ 172,555.00 ****
Fire	\$ 76,484.90	\$ 89,862.84 ***
RUT	\$ 51,781.73	
LOST	\$ 210,265.68	
TIF		
Casino Rev	\$ 334,807.29	
Debt Svc		
Capital Projects	\$ 55,787.81	***** \$ (200,000.00)
CC Funds		
Water	\$ 460,701.04	\$ 51,950.37 *
Sewer	\$ 176,855.78	\$ 140,587.49 **
Garbage	\$ 10,092.94	
Storm Water	\$ 17,246.98	
Total	\$ 1,733,116.89	\$ 454,955.70

Treasurer's Report \$ 3,211,558.27
 (All cash, CD's, Savings Accounts, Reserves)

- * Water-Reserves, Cashed in CD
- **Sewer-Engie \$35,000, \$45,000 Lift Station #1, \$60,587.49 Reserves
- ***FD unspent funds previous years
- **** General Fund 3 months reserves
- *****Capital Projects reserves to fund 200,000 lot sales

CITY of RIVERSIDE FUND BALANCES 2-28-2021

FUND	NAME	BALANCE 1-31-21	RESERVES	AVAILABLE FY 21
001	GENERAL	\$ 511,647.74	\$ (172,555.00)	\$ 339,092.74
002	FIRE	\$ 1,663,777.77	\$ (39,862.84)	\$ 1,623,914.93
110	R-USE	\$ 51,781.73	\$ -	\$ 51,781.73
121	LOST	\$ 210,265.68	\$ -	\$ 210,265.68
145	CASINO	\$ 334,807.29	\$ -	\$ 334,807.29
200	DEBT	\$ -	\$ -	\$ -
301	CAP PRO	\$ 55,787.81	\$ (200,000.00)	\$ (144,212.19)
302	CB FUNDS	\$ 1,023,485.68	\$ (1,023,485.68)	\$ -
600	WATER	\$ 512,651.41	\$ (51,950.37)	\$ 460,701.04
610	SEWER	\$ 317,443.27	\$ (60,587.49)	\$ 256,855.78
670	GARBAGE	\$ 10,092.94	\$ -	\$ 10,092.94
680	STORM	\$ 17,246.98	\$ -	\$ 17,246.98
	TOTAL	\$ 3,211,558.27	\$ (1,598,441.38)	\$ 1,613,116.89
POOLED CASH BALANCE 2/28/2021				
COMM. BUILDING SET A SIDE				
			INTEREST RATE	MATURITY
CD	18975	\$ 294,661.21	2.60%	2/5/2022
CD	19068	\$ 226,665.43	2.60%	8/30/2022
SAV	67928	\$ 502,159.04	0.25%	
TOTAL	302 FUND	\$ 1,023,485.68		
CHECK	35308	\$ 711,676.75	0.15%	
MM	67545	\$ 1,126,549.53	0.25%	
HILLS	2656940	\$ 349,846.31	0.24%	CD 921190 DEPOSIT \$260,813.16
TOTAL		\$ 3,211,558.27		
LESS RESERVES		\$ (1,598,441.38)		
LIVID CASH		\$ 1,613,116.89		2/28/2021

CITY OF RIVERSIDE
 POOLED CASH REPORT (FUND 999)
 AS OF: FEBRUARY 28TH, 2021

FUND ACCOUNT#	ACCOUNT NAME	BEGINNING BALANCE	CURRENT ACTIVITY	CURRENT BALANCE
<u>CLAIM ON CASH</u>				
001-1110	CHECKING ACCT-GENERAL FUND	545,382.10	(33,734.36)	511,647.74
002-1110	CHECKING ACCT-FIRE DEP.	167,831.12	(1,483.38)	166,347.74
003-1110	CHECKING ACCT.-EMS DEPT.	0.00	0.00	0.00
110-1110	CHECKING ACCT-ROAD USE TAX	47,418.00	4,363.73	51,781.73
121-1110	CHECKING ACCT-LOST	210,265.68	0.00	210,265.68
125-1110	CHECKING ACCT-TIF	0.00	0.00	0.00
145-1110	CHECKING ACCT-CASINO REVENUE	277,625.03	57,182.26	334,807.29
200-1110	CHECKING ACCT-DEBT SERVICE	0.00	0.00	0.00
301-1110	CHECKING ACCT-CAP PROJECTS	62,236.54	(6,448.73)	55,787.81
302-1110	COMMUNITY CENTER FUNDS	1,020,011.09	3,474.59	1,023,485.68
600-1110	CHECKING ACCT-WATER	502,438.34	10,213.07	512,651.41
610-1110	CHECKING ACCT-SEWER	308,692.37	8,750.90	317,443.27
670-1110	CHECKING ACCT-GARBAGE	9,764.12	328.82	10,092.94
680-1110	CHECKING ACCT-STORM WATER	<u>15,677.71</u>	<u>1,569.27</u>	<u>17,246.98</u>
TOTAL CLAIM ON CASH		<u>3,167,342.10</u>	<u>44,216.17</u>	<u>3,211,558.27</u>

CASH IN BANK - POOLED CASH

999-1110	CASH IN BANK	686,202.39	25,474.36	711,676.75
999-1112	PEOPLES BANK MONEY MARKET	1,126,333.52	216.01	1,126,549.53
999-1114	HILLS BANK	73,981.94	275,864.37	349,846.31
999-1115	CB FUND	502,062.75	96.29	502,159.04
999-1116	COMMUNITY BUILDING CD #18936	0.00	0.00	0.00
999-1117	COMMUNITY BUILDING CD#18975	292,742.74	1,918.47	294,661.21
999-1118	WATER RESERVES CD#921190	260,813.16	(260,813.16)	0.00
999-1119	COMMUNITY BUILDING CD#19068	<u>225,205.60</u>	<u>1,459.83</u>	<u>226,665.43</u>
SUBTOTAL CASH IN BANK - POOLED CASH		<u>3,167,342.10</u>	<u>44,216.17</u>	<u>3,211,558.27</u>

WAGES PAYABLE

999-2010	WAGES PAYABLE	<u>0.00</u>	<u>0.00</u>	<u>0.00</u>
SUBTOTAL WAGES PAYABLE		<u>0.00</u>	<u>0.00</u>	<u>0.00</u>
TOTAL CASH IN BANK - POOLED CASH		<u>3,167,342.10</u>	<u>44,216.17</u>	<u>3,211,558.27</u>

DUE TO OTHER FUNDS - POOLED CASH

999-2100	DUE TO OTHER FUNDS	<u>3,167,342.10</u>	<u>44,216.17</u>	<u>3,211,558.27</u>
TOTAL DUE TO OTHER FUNDS		<u>3,167,342.10</u>	<u>44,216.17</u>	<u>3,211,558.27</u>

CITY OF RIVERSIDE
 POOLED CASH REPORT (FUND 999)
 AS OF: FEBRUARY 28TH, 2021

FUND ACCOUNT#	ACCOUNT NAME	BEGINNING BALANCE	CURRENT ACTIVITY	CURRENT BALANCE
<u>DUE TO POOLED CASH</u>				
001-2020	ACCOUNTS PAYABLE	0.00	0.00	0.00
002-2020	ACCOUNTS PAYABLE	0.00	0.00	0.00
003-2020	ACCOUNTS PAYABLE	0.00	0.00	0.00
110-2020	ACCOUNTS PAYABLE	0.00	0.00	0.00
121-2020	ACCOUNTS PAYABLE	0.00	0.00	0.00
125-2020	ACCOUNTS PAYABLE	0.00	0.00	0.00
145-2020	ACCOUNTS PAYABLE	0.00	0.00	0.00
200-2020	ACCOUNTS PAYABLE	0.00	0.00	0.00
301-2020	ACCOUNTS PAYABLE	0.00	0.00	0.00
600-2020	ACCOUNTS PAYABLE	0.00	0.00	0.00
610-2020	ACCOUNTS PAYABLE	0.00	0.00	0.00
670-2020	ACCOUNTS PAYABLE	0.00	0.00	0.00
680-2020	ACCOUNTS PAYABLE	0.00	0.00	0.00
TOTAL DUE TO POOLED CASH		0.00	0.00	0.00

<u>DUE FROM OTHER FUNDS</u>				
999-1330	DUE FROM OTHER FUNDS	0.00	0.00	0.00
TOTAL DUE FROM OTHER FUNDS		0.00	0.00	0.00

<u>ACCOUNTS PAYABLE - POOLED CASH</u>				
999-2020	ACCOUNTS PAYABLE CONTROL	0.00	0.00	0.00
TOTAL ACCOUNTS PAYABLE POOLED CASH		0.00	0.00	0.00

*** PROOF CASH BALANCES ***

(A)		(B)		(C)	
CLAIM ON CASH	3,211,558.27	CLAIM ON CASH	3,211,558.27	CASH IN BANK	3,211,558.27
CASH IN BANK	3,211,558.27	DUE TO OTHER FUNDS	3,211,558.27	DUE TO OTHER FUNDS	3,211,558.27
DIFFERENCE	0.00		0.00		0.00

*** PROOF ACCOUNTS PAYABLE BALANCES ***

(D)		(E)		(F)	
AP PENDING	0.00	AP PENDING	0.00	DUE FROM OTHER FUNDS	0.00
DUE FROM OTHER FUNDS	0.00	ACCOUNTS PAYABLE	0.00	ACCOUNTS PAYABLE	0.00
DIFFERENCE	0.00		0.00		0.00

CITY OF RIVERSIDE
 MTD TREASURERS REPORT
 AS OF: FEBRUARY 28TH, 2021

FUND	BEGINNING CASH BALANCE	M-T-D REVENUES	M-T-D EXPENSES	CASH BASIS BALANCE	NET CHANGE OTHER ASSETS	NET CHANGE LIABILITIES	ACCURAL ENDING CASH BALANCE
001-GENERAL FUND	545,382.10	2,649.91	36,620.07	511,411.94	(244.09)	(8.29)	511,647.74
002-FIRE DEPARTMENT	167,831.12	302.00	1,785.38	166,347.74	0.00	0.00	166,347.74
110-ROAD USE TAX	47,418.00	8,679.15	4,315.42	51,781.73	0.00	0.00	51,781.73
121-LOCAL OPTION SALES TAX	210,265.68	0.00	0.00	210,265.68	0.00	0.00	210,265.68
125-TIF	0.00	0.00	0.00	0.00	0.00	0.00	0.00
145-CASINO REVENUE FUND	277,625.03	57,182.26	0.00	334,807.29	0.00	0.00	334,807.29
200-DEBT SERVICE	0.00	0.00	0.00	0.00	0.00	0.00	0.00
301-CAPITAL PROJECTS	62,236.54	0.00	6,448.73	55,787.81	0.00	0.00	55,787.81
302-COMMUNITY CENTER FUNDS	1,020,011.09	3,474.59	0.00	1,023,485.68	0.00	0.00	1,023,485.68
600-WATER FUND	502,438.34	26,577.73	16,364.66	512,651.41	0.00	0.00	512,651.41
610-SEWER FUND	308,692.37	25,689.63	16,938.73	317,443.27	0.00	0.00	317,443.27
670-LANDFILL/GARBAGE	9,764.12	7,302.57	6,973.75	10,092.94	0.00	0.00	10,092.94
680-STORM WATER	15,677.71	1,569.27	0.00	17,246.98	0.00	0.00	17,246.98
GRAND TOTAL	3,167,342.10	133,427.11	89,446.74	3,211,322.47	(244.09)	(8.29)	3,211,558.27

*** END OF REPORT ***



IMFOA
Iowa Municipal Finance
Officers Association

2021 Spring Conference
April 22-23 | Des Moines

Register online at
WWW.IMFOA.COM

*Uses same login as IMFOA Dues,
Certification or League websites*

Conference/Hotel Room Block:
Holiday Inn
Des Moines Airport
6111 Fleur Drive
Des Moines
(800) 248-4013

Training Topics :

- Let's Get it in the Open
- Payroll Forms and More
- 3rd Degree with Mickey
- Legislative Update
- Excel Tips and Tricks
- Where's the Money Coming From?

- **Banquet • Door Prizes**
- **Entertainment (DJ/Magician)**

Masks will be required, but not provided.
The conference is capped at 220 attendees, register early.

**Online pop-up clothing shop open at imfoa.org/apparel,
March 8-22, offering new styles as well as masks**

Grant Application Review 10/5/2020

Residential 50/50 match up to \$5,000/\$2,500

Name	Project	Project Amount	Requested Amount	Eligible Amount	Grant if Awarded
Spruce House LLC	Roof	\$14,740.00	\$2,500.00	\$5,000.00	\$2,500.00
Lexy Walgren	deck repair	\$845.50	\$422.75		\$422.75
Steve & Marcy Musser	Shutters, doors	\$ 5,208.00	\$ 2,500.00	\$ 4,538.00	\$ 2,269.00
Total if Awarded					\$5,191.75

Council approval
10/19/2020
10/19/2020
10/19/2020

Remaining Unallocated **\$682.39**

\$20,000.00 set aside for commercial grants

Grant Application Review 8-3-2020

Commercial 50/50 match up to \$20,000/\$10,000

Name	Project	Project Amount	Requested Amount	Eligible Amount	Grant if Awarded
Clean on Greene	Repair, painting	\$8,970.00	\$2,990.00	\$2,335.00	\$1,167.50
John Sojka (Madeline's)	Tuckpointing, window replacement	\$18,948.00	\$9,474.00	\$18,948.00	\$9,474.00
Total if Awarded					\$10,641.50

Council approval
9/8/2020
9/8/2020

Remaining Unallocated **\$9,358.50**

\$10,000.00 set aside for residential grants

Grant Application Review 8-3-2020

Residential 50/50 match up to \$5,000/\$2,500

Name	Project	Project Amount	Requested Amount	Eligible Amount	Grant if Awarded
Lexy Walgren	Deck repair	\$1,029.31	\$514.66	\$389.22	\$194.61
Charlie & Mariellen Bower	Roof	\$8,000.00	\$2,500.00	\$8,000.00	\$2,500.00
Spruce House LLC	Roof	\$24,000.00	\$2,500.00	\$5,000.00	\$2,500.00
Mary Beth Rozmus	Garage doors, exterior door, stain pergola	\$3,685.96	\$1,842.98	\$3,341.68	\$1,670.69
Bryan Lenz	driveway	\$3,240.35	\$1,620.17	\$3,240.00	\$1,620.17
Total if Awarded					\$3,290.86

withdrawn 9/30/20 to resubmit reapplying see below

Council approval
9/8/2020
9/8/2020
9/8/2020

Grant Application Review 9-28-2020

Residential 50/50 match up to \$5,000/\$2,500

Name	Project	Project Amount	Requested Amount	Eligible Amount	Grant if Awarded
Jeff Wieland	Level out, raise driveway	\$ 1,670.00	\$ 893.45	\$ 835.00	\$ 835.00
Total if Awarded					\$4,125.86

Council approval
10/5/2020



5276 Oak Crest Hill Rd. SE
Riverside, IA 52327
319-679-4276
office@absoluteoutdoorservicesia.com

QUOTE FORM

Date: 3-11-2021

Customer Name City of Riverside c/o Christine Yancey

Address _____

City Riverside ZIP 52327

Phone 319-648-3501

Email cityadmineriversideiowa.gov

LANDSCAPING QUOTATION

Job Description:

Cost: _____

Leaf removal service

Our proposal to you is to offer you guys our machine and labor set on your schedule. I would guess a couple days in the spring and 4-6 days/weeks in the fall. Something we can schedule to happen after the weekend so that it gives time to get the material to the parkways.

We would not charge you for the equipment. Our labor cost would be \$45/labor hour. You provide the dumpsite locally. We would begin charging covering our cost of the way down and would stop charging after the job is completed.



Job 2:

Cost: _____

Job 3:

Cost: _____

Special Project Notes:

Equipment/ Materials needed:

Design Area

*All prices are subject to Iowa Sales Tax. If you would like to accept this proposal please sign and return, via email or text. Signature

Leaf pickup program

Two days in spring- April

Four days in fall- Last week of October to third week in November

Leaves raked to the curb, not in the street, picked up one day per week

Charge is \$45.00/hour to go over entire town

Leaves would be taken to the shop in a holding area to be composted. Compost would then be available to residents either at a nominal charge or free.

To: WEDG Board of Directors

From: Mary Audia, Executive Director
Office Phone 319.653.3942
Mobile 319.541.9577
wedg@washingtioniowa.org



RE: WEDG Director Activity Update

Date: Monday, March 8, 2021

Greetings to each of you. I hope this report finds you healthy, happy and enjoying this spring-like weather.

Of special note: the WEDG board meeting for March will be **March 26th at noon**. We will resume the third Friday of the month in April. You should have received a zoom link. If you have any questions, don't hesitate to contact me.

I was fortunate to have these meetings and opportunities this past week, many with a common theme of workforce shortages, affordable housing shortages and childcare challenges:

Community Foundation of Washington County...became a voting member elected by the CFWC. Looking forward to working with this dynamic group of volunteers.

Elliott Group...met with the Elliott Group team. Discussed past collaborations with WEDG and ideas for working together in the future. Asked them to send building and land listings so I might post them in LOIS. Following up with members of the Elliott team this week.

Advanced Manufacturing Resources meeting with Dr. Kremer, Dr. Frank of ISU. Attended virtual Zoom meeting with Dr's Kremer and Frank of ISU. They will send me further resources on Advanced Manufacturing to rekindle that focus for Washington County.

WA City Council Meeting...attended Washington City Council meeting virtually. They had just started utilizing a new conferencing system. See the City website for details.

Marcus Fedler of Custom Impressions...Patty Koller (WCRF) met with Marcus to discuss signage for our office windows and Greiner front door. Also, congratulated him on his election win for Washington County Supervisor.

SS Solutions...met with Bob and Clark to discuss grant opportunities surrounding childcare and workforce. I have completed both grant applications and am awaiting a formal proposal from First Childrens' Finance regarding a study for Washington county studying the effects of childcare, or lackof, and our workforce challenges.

Best of Iowa Synchronist Webinar...attended a virtual Synchronist Webinar to learn more about latest developments with the Synchronist system, best practices and contact information for assistance.

Washington SEO and Support meeting with City of WA, Chamber and WEDG and Running Robots.

Looking for volunteers to assist with reception for WEDG and WCRF. Please spread the word!

Website...constantly updating and blogging. Please "like, follow or friend" WEDG on LinkedIn, Instagram, Facebook and Twitter. Let's get the word out about fabulous Washington County!

Annual Dinner Meetings...tonight's the night! After months of planning and preparation, we are embarking on a one-of-a-kind hybrid Annual dinner this evening with many ways to participate. We are so grateful to all our Sponsors:

Presenting Sponsors...WCHC and Riverside Casino and Golf Resort.

Our Production Sponsor...Clay Whisler of Whisler Studios.

And many thanks to **our local restaurants for hosting this year's event:**

JP's 207, Cafe Dodici, Lebowski's Rock n' Bowl, Kalona Brewing Co.

Thank you to sponsors:

Farm & Home Mutual Insurance Association,

Gallagher Farms,

Custom Impressions,

Federation Bank, CBI Bank & Trust, Hills Bank, Washington State Bank, Community 1st Credit Union and Lloyd, McConnell, Davis & Lujan, LLP .

Special thanks to all our **Raffle Prize Sponsors.**

WEDG is now in our new home! 120 E. Main St, Suite #4 (PO Box 908), Washington, IA 52353. It's beautiful! Patty Koller has moved in and is delightful to share space with! We hope to do a public thank you/ safe open house to thank the Riverboat Foundation and all of our investors for making this possible. Stay tuned!

Meetings this week include:

Annual Dinner Event

WA County Supervisors' Meeting

MSW Board Meeting

Transportation Sector Board Meeting (Kirkwood)

Jeff Hazelett, Elliott Realty

Washington Noon Rotary

Respectfully submitted,

Mary Audia

Executive Director, WEDG

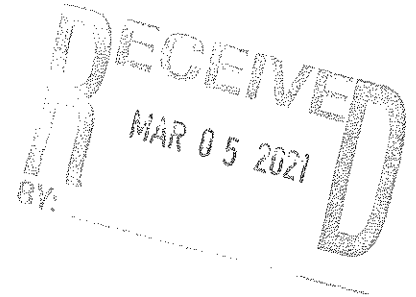
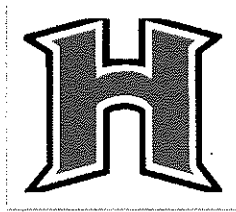

Highland Class of 2022
1715 Vine Ave
Riverside, Iowa 52327

To Whom It May Concern:

The Highland Junior Class is currently planning to host the Junior/Senior Prom on April 17, 2021. Due to the craziness of the Pandemic we have had to be creative with our fundraising efforts. We are hoping to plan a memorable, safe, and fun evening for all of our Junior and Senior Classmates, but we will need to raise money for this exciting time.

We are asking local businesses to support our goals by donating any amount you would like in order help us achieve our plans of presenting a memorable and jaw dropping evening. The items we will be using the donations for include decorations, DJ, rentals, snacks, lights, etc.

With your donation your business name will be added to the program that is handed out at prom.

We thank you for your support and appreciate any amount you would like to donate.

Please return the bottom portion by March 15, 2021 to the following address:

Highland High School Class of 2022
Attention: Kelli
1715 Vine Avenue
Riverside, Iowa 52327

We appreciate your support.

Sincerely,

The Class of 2022

Business Name: _____
Address: _____
Email: _____

Amount Enclosed: \$ _____

Please Makes Checks payable to Highland High School